



EARTHQUAKE SOUND

PowerHouse Series Amplifiers Owners Manual

MODELS:

PH800W/2

PH1000W/2

PH2200W/4

PH2000W/D1

PH2000W/D1.1

PH5000W/D1

PH10000W/D1

PH20000W/D1

POWERHOUSE



The Sound That Will Move You.

Earthquake Sound reserves the right to amend details of the specifications without notice.
Copyright © Earthquake Sound Corporation
Earthquake Sound Corporation • 2727 McCone Avenue Hayward CA, 94545 • Phone: 510-732-1000 Fax: 510-732-1095



Sound That Will Move You.

Table Of Contents

Cautions and Advisories Page 2
 Warranty Page 3 - 4
 Specifications Page 5
 PH800W/2 Page 6 - 7
 PH1000W/2 Page 8 - 9
 PH2200W/4 Page 10 - 11
 PH2000W/D1 Page 12 - 13
 PH2000W/D1.1 Page 12 - 13
 PH5000W/D1 Page 14 - 15
 PH10000W/D1 Page 16 - 18
 Installation Example Page 19

THANK YOU

Thank you for choosing Earthquake Sound's high-end line of PowerHouse amplifiers for superior enhancement of your mobile audio system. With proper installation and responsible listening, your amplifier(s) will give you years of near perfect sound reproduction.

We strongly recommend you to have your new amplifier(s) installed by an authorized Earthquake Sound dealer: Installation professionals employed by your dealer have the correct tools and knowledge to install your amplifier(s) neatly and successfully. Also, when your new products are installed by an authorized dealer, your product will include a FIVE YEAR LIMITED WARRANTY (1-Year for Digital models excluding PH2000W/D1 and PH2000W/D1.1). If you choose to perform your own installation, your warranty will be subject to limitations. Dealer policies on handling warranty requests may vary from one dealer to the next. Please read the warranty information in its entirety and use good judgment when making these vital decisions.

CAUTION: Earthquake Amplifiers are capable of generating high sound pressure levels. You should exercise caution when operating these amplifier systems. Long term exposures to high levels of sound pressure will cause permanent damage to your hearing. Sound pressure levels exceeding 85dB can be dangerous with constant exposure. Set your audio system to a comfortable loudness level. Earthquake Sound Corporation does not assume liability for damages resulting from the direct use of Earthquake amplifiers or other Earthquake products, and urges users to play their music at moderate listening levels.

SOUND LEVEL DBA	DURATION IN HOURS	
90	8	THE CHART (ON THE SIDE) SHOWS THE U.S. GOVERNMENTS OCCUPATIONAL SAFETY AND HEALTH ADMINISTRATION (OSHA) REGULATIONS WHICH WERE IN EFFECT AT THE TIME OF THIS PUBLICATION FOR PERMISSIBLE NOISE EXPOSURE, PER 29CFR1910.95, TABLE G-16.
92	6	
95	4	
97	3	
100	2	
102	1- 1 1/2	
105	1	
110	1/2	
115	1/4 or less	

WARRANTY

Five (5) year limited warranty; PH800W/2, PH1000W/2, PH2200W/4, PH2000W/D and PH2000W/D1.1:

Earthquake warrants the original purchaser that all Factory Sealed New Audio Products be free from defects in material and workmanship, under normal and proper use, for a period of five (5) years from the date of purchase (as shown on the original bill of sale with serial number affixed/written on it). **The five (5) year limited warranty period is valid only if the product was purchased from and properly installed by an authorized Earthquake Sound dealer/installer, and the warranty registration card is properly completed and mailed to Earthquake Sound Corporation.**

- Products that were purchased from non-authorized dealers are not covered by warranty.
- If the product was not installed by an authorized dealer, then only a ninety (90) day warranty period applies.
- Open box, B-stock and DEMO products have only thirty (30) day warranty from the date of purchase.

(A) Five (5) year limited warranty plan coverage guidelines:

- **First year:** Earthquake pays for labor, parts, and ground freight (only in US mainland, not including Alaska and Hawaii) back to customer.
- **Second, third, fourth & fifth year:** Earthquake pays labor only. Customer must pay for parts, re-packing (if needed) and freight both ways.
- **Earthquake agrees to repair or replace - at our option - all such defective products/parts.**

(B) Warning:

Products (sent in for repair) that are tested by Earthquake technicians and deemed to have no problem(s) will not be covered by the five (5) year limited warranty. Customer will be charged a minimum of one (1) hour of labor (ongoing rates) plus shipping and handling charges.

(C) Warranty Limitations:

- Defective products/parts have not been altered or repaired by other than an Earthquake factory approved technician.
- Products/parts are not subjected to negligence, improper use, or accident, damaged by improper line voltage, used with incompatible products, or have its serial number or any part of it altered, defaced or removed, or have been used in any way that is contrary to Earthquake's written instructions.
- Damages to speaker cabinet and cabinet finish due to misuse, abuse, or use of improper use of cleaning materials/methods.
- Bent speaker frame, broken speaker connectors, holes in speaker cone, surround & dust cap, burnt speaker voice coil.
- Fading, deterioration of speaker components and finish due to improper exposure to elements.
- Bent amplifier casing, damaged finish on the casing due to abuse, misuse, or improper use of cleaning material.
- Burnt tracers on PCB.
- Product/part damaged due to poor packaging or abusive shipping conditions.
- Subsequent damage to other products.

WARRANTY

A warranty claim will not be valid if the warranty registration card is not properly filled and returned to Earthquake with a copy of the purchase receipt.

(E) Service Request:

To receive product(s) service, contact Earthquake service department at (510) 732-1000 and request an RMA (Return Material Authorization) number. Items shipped without a valid RMA number will be refused. Make sure you provide us with your complete/correct shipping address (NO P.O. Box), a valid phone number and a brief description of the problem you are experiencing with the product(s). In most cases, our technicians might be able to resolve the problem over the phone, thus eliminating the need to ship the product(s).

(F) Shipping Instructions:

Product(s) must be packaged in its original protective box(es) to minimize transport damage, otherwise a re-packing charge may apply. Shipper claims regarding items damaged in transit must be presented to carrier. Earthquake Sound Corporation reserves the right to refuse products that are improperly packed. Copy of original purchase receipt must accompany product(s) being returned for service. We encourage you to include with the package a written description of the problem.
Ship product to:

Earthquake Sound Corp.
2727 Mc Cone Avenue. Hayward, CA 94545
Phone: (510) 732-1000

You are responsible for the cost of shipping and insurance for the product(s). Please be sure to write the RMA number on every box.

(G) Disputes Resolution:

All disputes - between client(s) and Earthquake Sound Corporation - resulting from the five (5) year limited warranty policy must be resolved according to the laws & regulations of the county of Alameda, California.

NOTE: For warranty guidelines on the PH5000W/D1, PH10000W/D1 and PH20000W/D, please refer to the one provided in the product packaging.

Please keep this warranty information in your files for future reference if necessary. It is recommended that you stick your serial number here for future reference.

SERIAL NUMBER

SPECIFICATIONS

Model	Channels	Max Power	Power 4-Ohm Bridged	Power 1-Ohm	Power 2-Ohm Bridged	Power 4-Ohm Stereo	Weight	Dimensions (HxWxL)
PH800W/2	2	800	1 x 400	N/A	2 x 200	2 x 105	9	2.375" x 10.125" x 8.5"
PH1000W/2	2	1000	1 x 500	N/A	2 x 250	2 x 145	11	2.375" x 10.125" x 10.375"
PH2200W/4	4	1400	2 x 500	N/A	4 x 250	4 x 130	13.5	2.375" x 10.125" x 13.375"
PH2000W/D1	1 (MONO)	1400	MONO	N/A	1 x 1000	1 x 500	13	2.375" x 10.125" x 12"
PH2000W/D1.1	1 (MONO)	1400	MONO	1 x 1000	1 x 700	1 x 450	13	2.375" x 10.125" x 12"
PH5000W/D1	1 (MONO)	5000	MONO	1 x 5000	1 x 3000	1 x 860	16	2.375" x 10.125" x 15"
PH10000W/D1	1 (MONO)	5000	MONO	1 x 5000	1 x 3000	1 x 900	18	2.375" x 10.125" x 16.5"
PH20000WD	2	20000	6000	N/A	1 x 20,000	2 x 3000		4.5" x 12" x 28.625"

*** ALL MEASUREMENTS ARE MADE USING RESISTIVE LOAD ***
*** ALL POWER RATINGS ARE PEAK POWER ***

SIGNAL SENSOR

This new feature allows you to eliminate the use of a remote wire to turn on your amplifier.

- When in "AUTO ON" mode, the amplifier will automatically detect an incoming signal once the stereo is turned on. If the amplifier does not detect a signal within 20 minutes, it will automatically shut down.
- When in "REMOTE ON" mode, the amplifier relies on the remote wire to detect a signal.

NOTE: The RCA outputs must be inserted in CH1/2 for the amplifier to detect any incoming signal.

NOTE: In some cases when the amplifier is on "AUTO ON" mode, if your system generates noise through the RCA wire and therefore waking up the amplifier, you may want to switch your amplifier installation to the "REMOTE ON" mode (must use the turn on wire).

PH800W/2

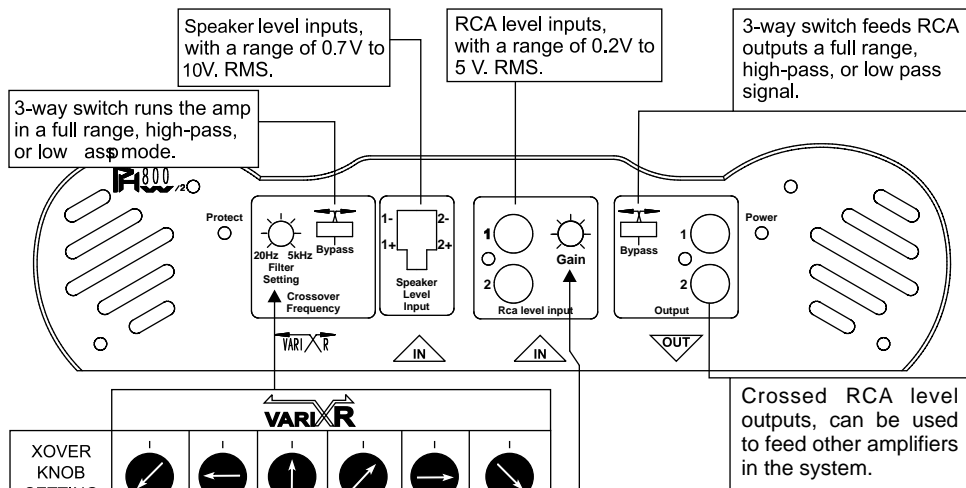

XOVER KNOB SETTING	20Hz	27Hz	45Hz	75Hz	170Hz	5kHz

MAX INPUT VOLTAGE BEFORE CLIPPING	GAIN KNOB SETTING				
	MIN	9	12	3	MAX
RCA LEVEL	5V	3.5V	0.5V	0.28V	0.20V
SPKR LEVEL	10V	8V	1.5V	0.75V	0.7V

LED INDICATORS
 ○ GREEN = POWER
 ○ RED = PROTECTION

WARNING
 The gain knob is not a volume control. It is designed to match the input level of the amp to the output level of the source unit. Over driving -clipping- the input stage of the amp will cause damage to the amplifier (Please refer to table for settings).

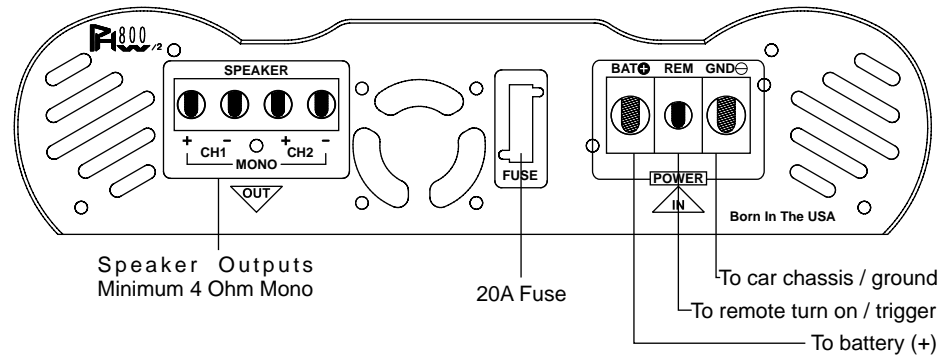

FRONT STEREO IMAGES

Set Xover knob to 9 O'clock (27Hz), & set Xover switch to high-pass.

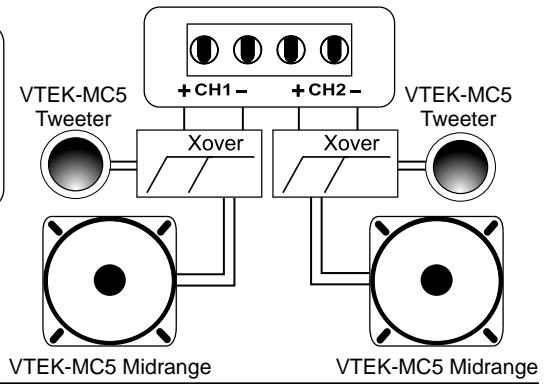
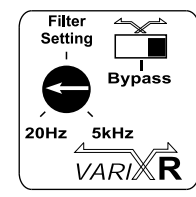

WARNING The PH is designed to operate in stereo or mono mode. When used in stereo applications, a minimum load of 2 ohms per channel is required.

REAR FILL STAGING

Set Xover knob to Minimum (20Hz), & set Xover switch to high-pass.

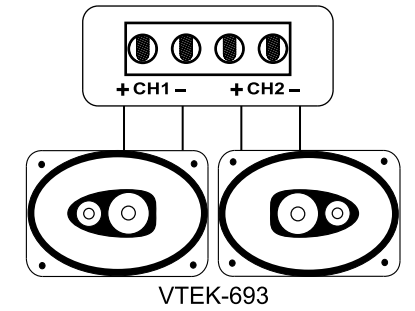
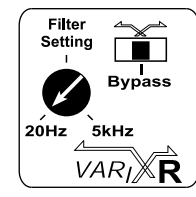

BASS APPLICATIONS

Set Xover knob to 2 O'clock (75Hz), & set Xover switch to low-pass.

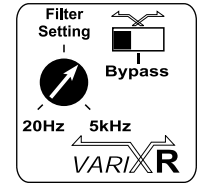

WARNING The PH is designed to operate in mono mode. When bridging the two channels, a minimum load of 4 ohms is required.

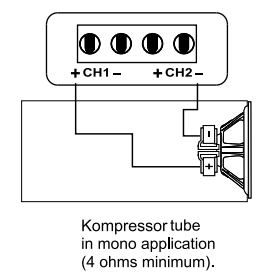
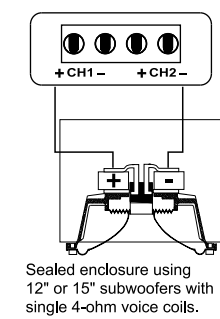
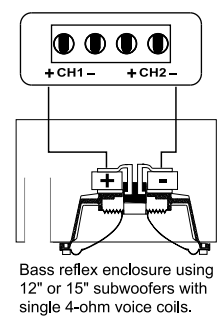

PH1000W/2

+18dB boost @ 45Hz designed to shape/boost the response curve in a low-pass mode application.

+12dB boost @ 12kHz essential boost for high-pass amplifier applications

3-way switch runs the amp in low-pass, full-range or high-pass mode.

RCA level inputs, with a range of 0.2V to 5V. RMS.

3-way switch feeds RCA outputs a low-pass full-range or high pass signal.

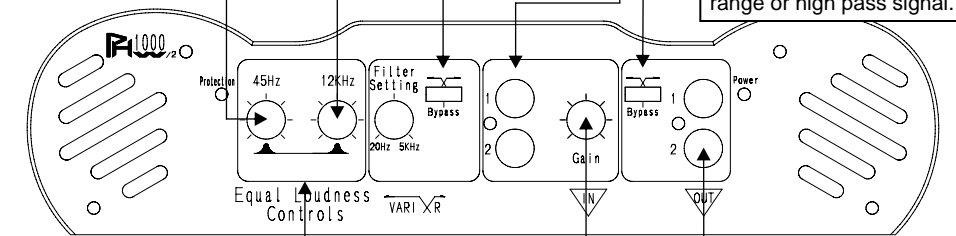

Tonal controls CH1/2:
+ 12dB boost @ 12kHz
+ 18dB boost @ 45Hz.

Crossed RCA level outputs, can be used to feed other amplifiers in the system.

VARIXR						
XOVER KNOB SETTING						
	20Hz	27Hz	45Hz	75Hz	170Hz	5kHz

GAIN KNOB SETTING					
MAX INPUT VOLTAGE BEFORE CLIPPING					
RCA LEVEL	5V	3.5V	0.5V	0.28V	0.20V
SPKR LEVEL	10V	8V	1.5V	0.75V	0.7V

LED INDICATORS
 GREEN = POWER
 RED = PROTECTION

WARNING

The gain knob is not a volume control. It is designed to match the input level of the amp to the output level of the source unit. Over driving -clipping- the input stage of the amp will cause damage to the amplifier (Please refer to table for settings).

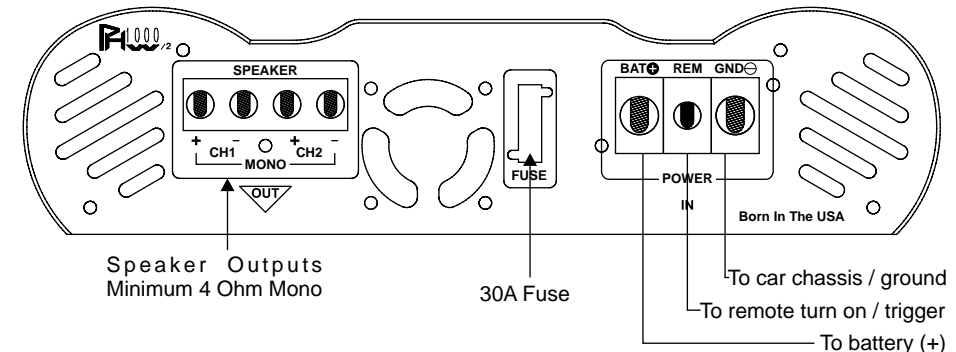

FRONT STEREO IMAGES

Set Xover knob to 9 O'clock (27Hz), & set Xover switch to high-pass.

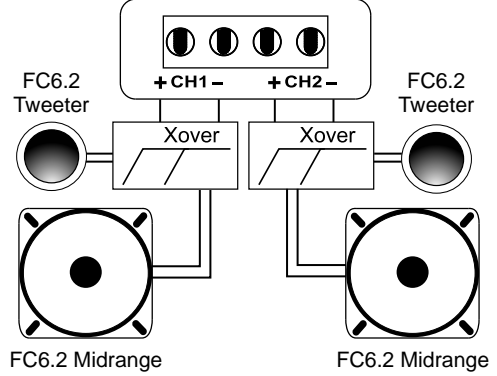
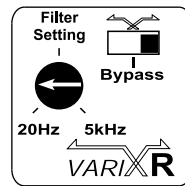

WARNING

The PH1000W/2 is designed to operate in stereo or mono mode. When used in stereo applications, a minimum load of 2 ohms per channel is required.

REAR FILL STAGING

Set Xover knob to Minimum (20Hz), & set Xover switch to Full Range

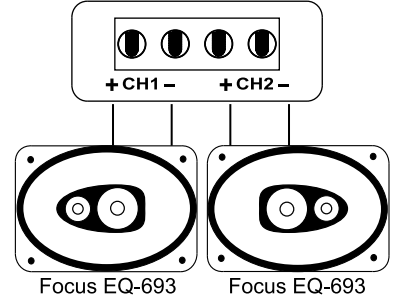
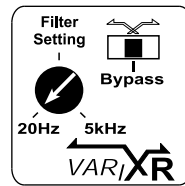

BASS APPLICATIONS

Set Xover knob to 2 O'clock (75Hz), & set Xover switch to low-pass.

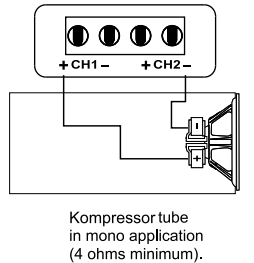
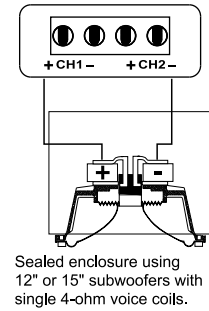
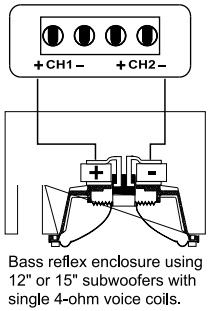
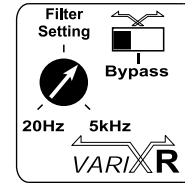

WARNING

The PH1000W/2 is designed to operate in mono mode. When bridging the two channels, a minimum load of 4-ohms is required.

PH2200W/4

2-way variable crossover 20Hz to 5kHz. Dedicated for CH1/2.

3-way switch feeds RCA outputs 1/2 a full range, high-pass, or low pass signal.

3-way switch feeds, RCA outputs 3/4 a full range, high-pass or low-pass signal.

2-way variable crossover 20Hz to 5kHz. Dedicated for CH3/4.

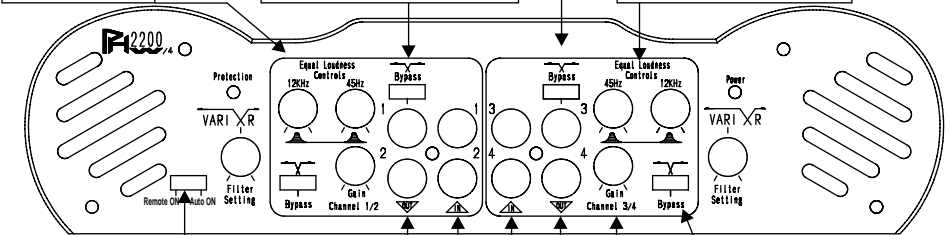

Signal Sensor: Remote ON/Auto ON feature (see page 5).

Four RCA level inputs crossed outputs, can be used to feed other amplifiers in the system

3-way switch for each block runs CH1/2 or CH3/4 in low-pass, full-range or high-pass mode.

Tonal controls CH3/4:
+ 12dB boost @ 12kHz
+ 18dB boost @ 45Hz

Four RCA level inputs with a range of 0.2V to 5V. RMS.

VARIX R						
XOVER KNOB SETTING						
	20Hz	27Hz	45Hz	75Hz	170Hz	5kHz

GAIN KNOB SETTING					
MAX INPUT VOLTAGE BEFORE CLIPPING					
	MIN	9	12	3	MAX
RCA LEVEL	5V	3.5V	0.5V	0.28V	0.20V
SPKR LEVEL	10V	8V	1.5V	0.75V	0.7V

LED INDICATORS

- GREEN = POWER
- RED = PROTECTION

WARNING

The gain knob is not a volume control. It is designed to match the input level of the amp to the output level of the source unit. Over driving -clipping- the input stage of the amp will cause damage to the amplifier (Please refer to table for settings).

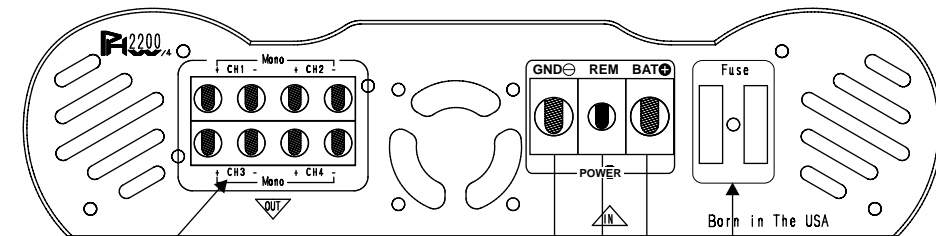

Speaker Outputs Minimum 4 Ohm Mono

To battery (+)
To remote turn on / trigger
To car chassis / ground

Two 30A Fuses

FRONT STEREO IMAGES CHANNELS 1/2

Set Xover knob to 9 O'clock (27Hz), & set Xover switch to high-pass.

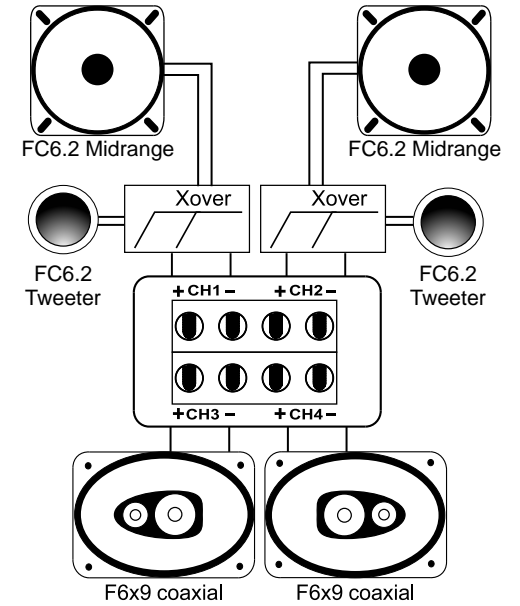
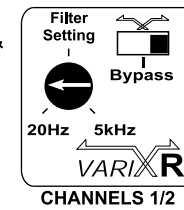

REAR FILL STAGING CHANNELS 3/4

Set Xover knob to Minimum (20Hz), & set Xover switch to by-pass, (full-range)

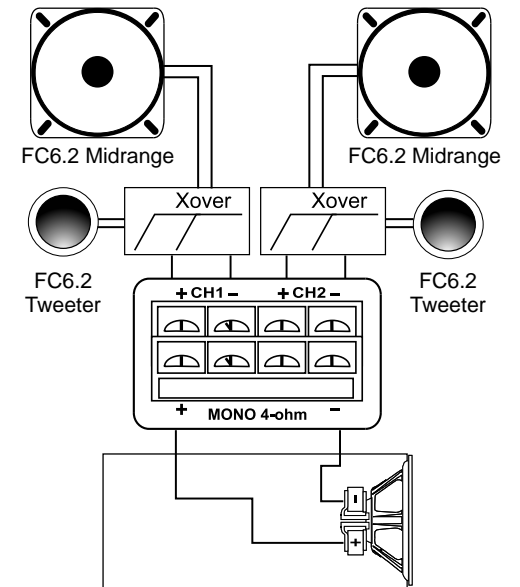
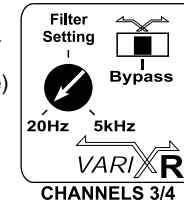

Kompessor tube in mono application (4 ohms minimum).

FRONT STEREO IMAGES CHANNELS 1/2

Set Xover knob to 9 O'clock (27Hz), & set Xover switch to high-pass.

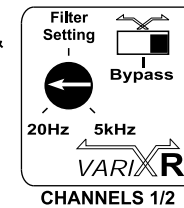

BASS APPLICATIONS - CHANNELS 3/4 mono

Set Xover knob to 2 O'clock (75Hz), & set Xover switch to low-pass.

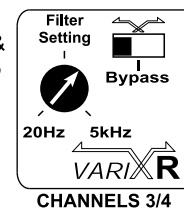

PH2000W/D1 PH2000W/D1.1

Variable 10dB boost at 40Hz.
Perfect tool for high SPL scores.

GAIN KNOB SETTING					
MAX INPUT VOLTAGE BEFORE CLIPPING	6V	3.5V	1.3V	0.7V	0.2V

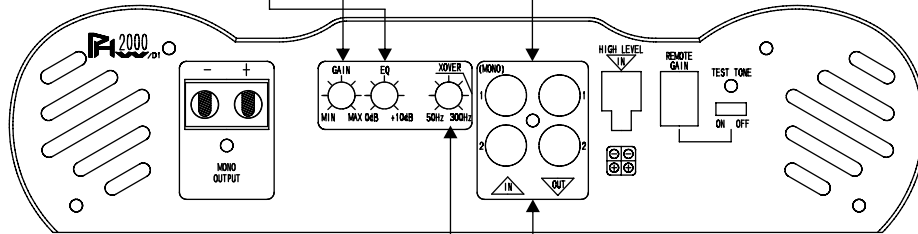

Full time low-pass variable filter
12dB/Oct slope, range from 50
to 300Hz

Through output feeds other
amplifiers in the audio system.
NOT EFFECTED BY THE LOW-
PASS FILTER.

XOVER KNOB SETTING						
XOVER SETTING POINT	50Hz	55Hz	85Hz	150Hz	250Hz	300HZ

LED INDICATORS
 GREEN = POWER
 RED = PROTECTION

WARNING

Before you install the amp, take note of the following:
#1. You have to confirm that your power supply can deliver spontaneous power to the amplifier when needed to propel the load.

#2. Bullet-proof ground: the ground cable must be 4-gauge minimum, it should be very short, and well grounded to the chassis.

WARNING

The gain knob is not a volume control. It is designed to match the input level of the amp to the output level of the source unit. Over driving -clipping- the input stage of the amp will cause damage to the amplifier (Please refer to table for settings).

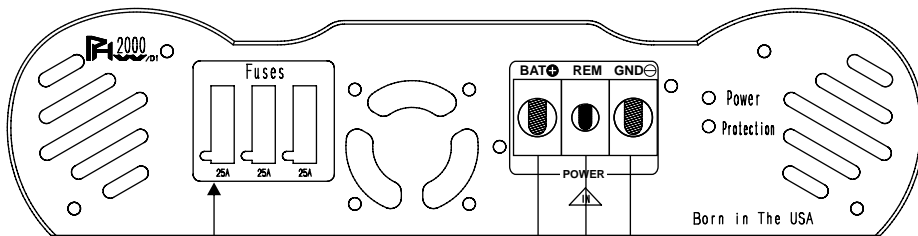

Three 25A Fuses

To battery (+)
To remote turn on / trigger
To car chassis / ground

Born in The USA

* Test the alternator output. Factory alternators will produce 60-80 amperes at best. Wear and heat will reduce the output by 40%.

* Alternator ground (-) must be reinforced, use 4-gauge cable instead of the factory 8-gauge.

* Alternator positive (+) to battery (+) must be reinforced. Use 4-gauge cables.

* Check your battery condition. Batteries degrade after a while.

* Battery (+) to amplifier (+) must be a 4-gauge cable.

* Ground amplifier to chassis using 4-gauge cable, keep the cable short (Maximum 2-feet).

* Use 1 farad capacitor to compensate for surges in demand.

* We recommend the use of one (1) auxiliary battery.

Two Single 4-Ohm Subwoofers @ 2-Ohm

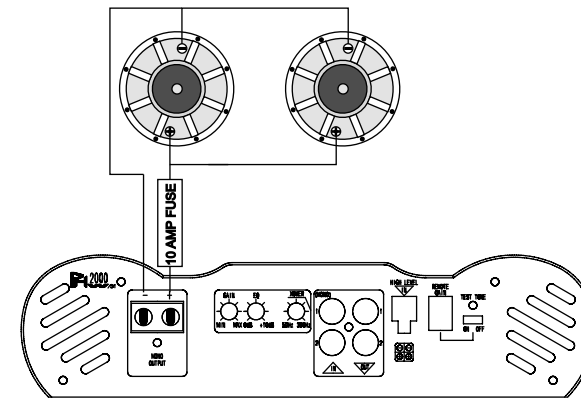

USE THREE 25-
AMPERE FUSES
TO PROTECT THE
AMPLIFIER

Two Dual 4-Ohm Subwoofers @ 1-Ohm

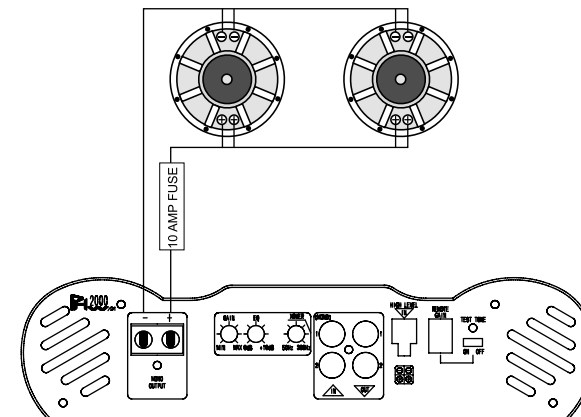

WARNING

THIS CONFIGURATION
IS FOR USE WITH
PH2000W/D11 1-Ohm
AMPLIFIER ONLY

PH5000W/D1

SIGNAL SENSOR: This feature allows you to eliminate the use of a remote wire to turn on your amplifier. In AUTO mode the amp will automatically detect an incoming signal when the stereo is turned on. If the amplifier does not detect a signal within 20min, it will automatically shutdown. When in REMOTE mode the amplifier relies on the remote wire to detect a signal.

XOVER KNOB SETTING						
XOVER SETTING POINT	20Hz	27Hz	40Hz	50Hz	90Hz	200HZ
			RECOMMENDED SETTING			

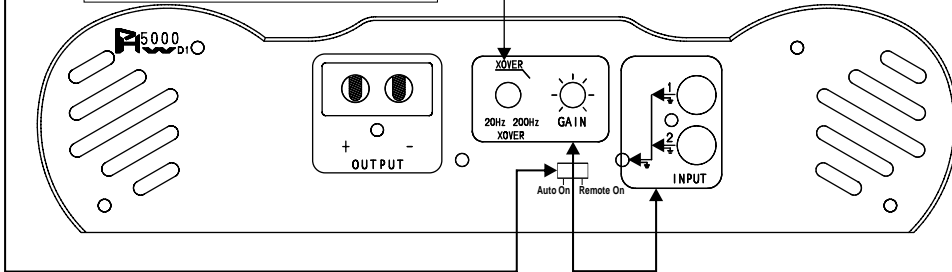

FUSE RATING SHOULD BE NO LESS THAN 120 AMPERES

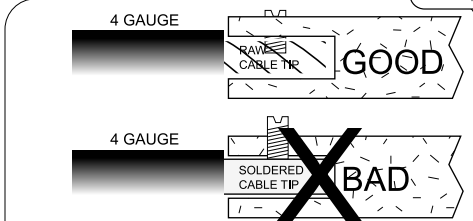

DO NOT SOLDER THE TIP OF THE POWER CABLE (+&-). IT REDUCES THE CONTACT SURFACE BETWEEN THE CABLE AND THE INSIDE OF THE TERMINAL. WHEN TIGHTENING THE SCREW, A RAW CABLE (NO SOLDER) EXPANDS INSIDE THE TERMINAL CREATING LARGER CONTACT SURFACE; THUS ELIMINATING HOT JUNCTIONS.

GAIN KNOB SETTING					
MAX INPUT VOLTAGE BEFORE CLIPPING	6V	3.5V	1.3V	0.7V	0.2V

LED INDICATORS
 GREEN = POWER
 RED = PROTECTION

WARNING
 The gain knob is not a volume control. It is designed to match the input level of the amp to the output level of the source unit. Over driving -clipping- the input stage of the amp will cause damage to the amplifier (Please refer to table for settings).

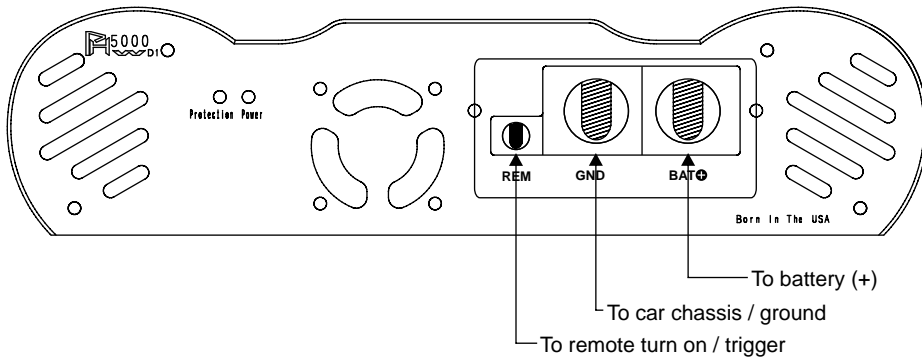

- Test the alternator output. Factory alternator will produce 60 to 80 amperes at best. Wear and heat will reduce the output by 40%.
- Alternator ground (-) must be reinforced, use 4-gauge cable instead of the factory 8-gauge.
- Alternator positive (+) to battery (+) must be reinforced. Use 4-gauge cables.
- Check your battery condition. Batteries degrade after a while.
- Battery (+) to amplifier (+) , must be a 4-gauge cable.
- Ground amplifier to chassis using 4-gauge cable, keep the cable short (maximum 2-feet).
- Use 1 farad capacitor to compensate for surges in demand.
- We recommend the use of one (1) auxiliary battery.

One Subwoofer

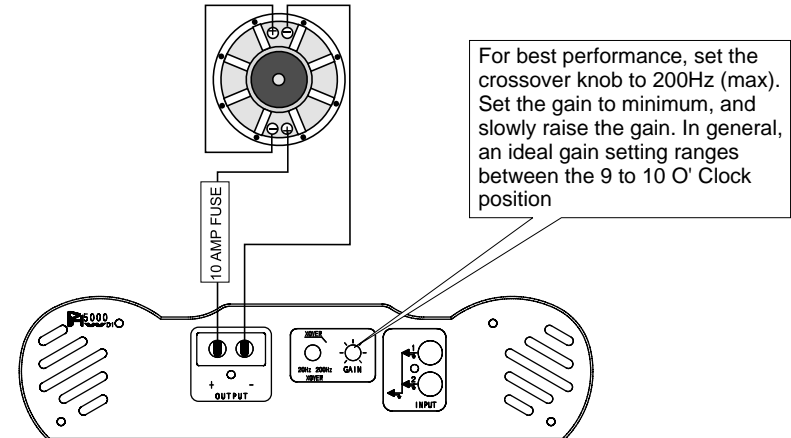

Two Subwoofers

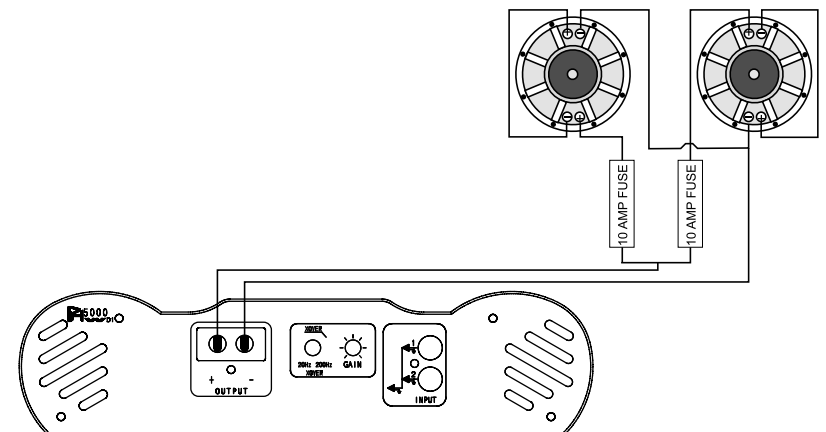

PH1000W/D1

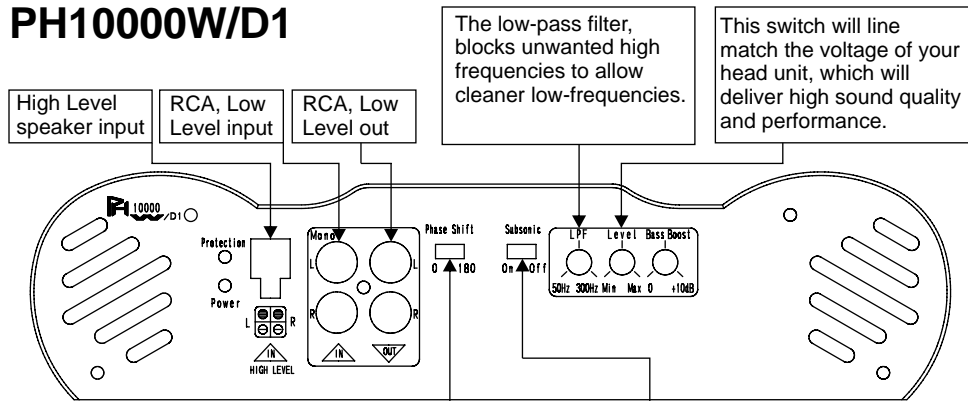

This switch will reverse the phase of PH1000's output with respect to its input. Although the position that yields the most upper bass is technically correct, you may choose the position that better suits your needs.

Peaks or dips occur at about 40Hz — around the frequency of a low bass guitar note. Use this control to correct that peak or dip.

FUSE RATING SHOULD BE NO LESS THAN 120 AMPERES PER AMPLIFIER

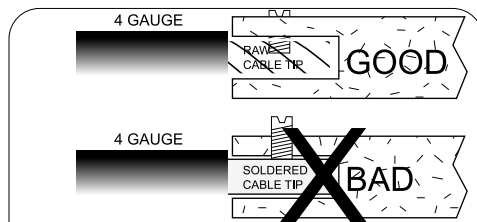

DO NOT SOLDER THE TIP OF THE POWER CABLE (+&-). IT REDUCES THE CONTACT SURFACE BETWEEN THE CABLE AND THE INSIDE OF THE TERMINAL. WHEN TIGHTENING THE SCREW, A RAW CABLE (NO SOLDER) EXPANDS INSIDE THE TERMINAL CREATING LARGER CONTACT SURFACE; THUS ELIMINATING HOT JUNCTIONS.

LED INDICATORS
 ○ GREEN = POWER
 ○ RED = PROTECTION

WARNING

The gain knob is not a volume control. It is designed to match the input level of the amp to the output level of the source unit. Over driving -clipping- the input stage of the amp will cause damage to the amplifier (Please refer to table for settings).

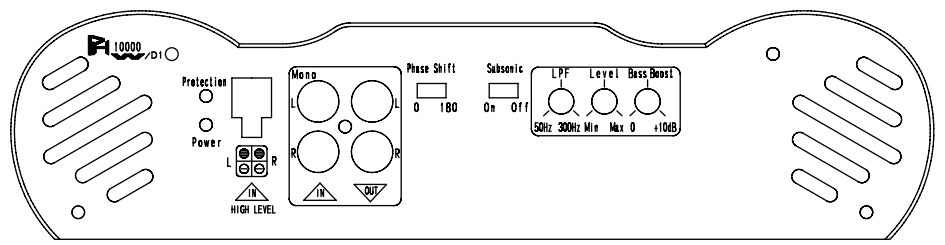
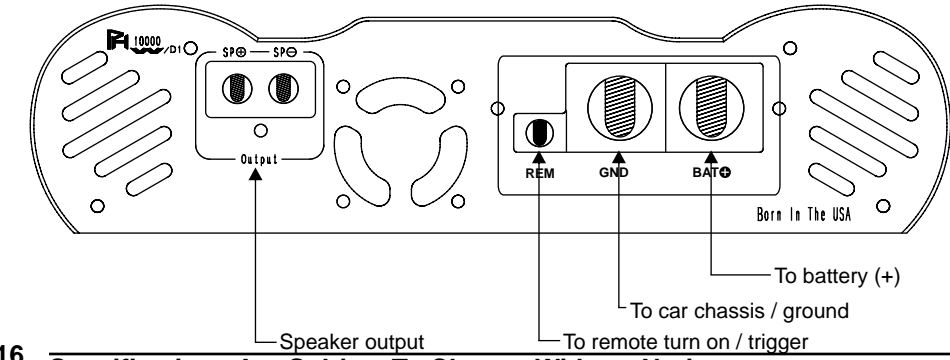

"RCA level" audio signal needed to clip the input stage (bass boost at minimum)

L R	Bass Boost Min	Gain Level Min	Gain Level 9:00	Gain Level 12:00	Gain Level 3:00	Gain Level Max
	12 Volts	6 Volts	1 Volt	0.7 Volt	0.5 Volt	

"RCA level" audio signal needed to clip the input stage (bass boost at maximum)

L R	Bass Boost Max	Gain Level Min	Gain Level 9:00	Gain Level 12:00	Gain Level 3:00	Gain Level Max
	6 Volts	2.7 Volts	0.8 Volt	0.5 Volt	0.2 Volt	

"SPEAKER level" audio signal needed to clip the input stage (bass boost at minimum)

High Level	Bass Boost Min	Gain Level Min	Gain Level 9:00	Gain Level 12:00	Gain Level 3:00	Gain Level Max
	N / A	16 Volts	8 Volts	4 Volts	3 Volts	

"SPEAKER level" audio signal needed to clip the input stage (bass boost at maximum)

High Level	Bass Boost Max	Gain Level Min	Gain Level 9:00	Gain Level 12:00	Gain Level 3:00	Gain Level Max
	N / A	14 Volts	4 Volts	2 Volts	1 Volt	

PH10000W/D1 - Linking

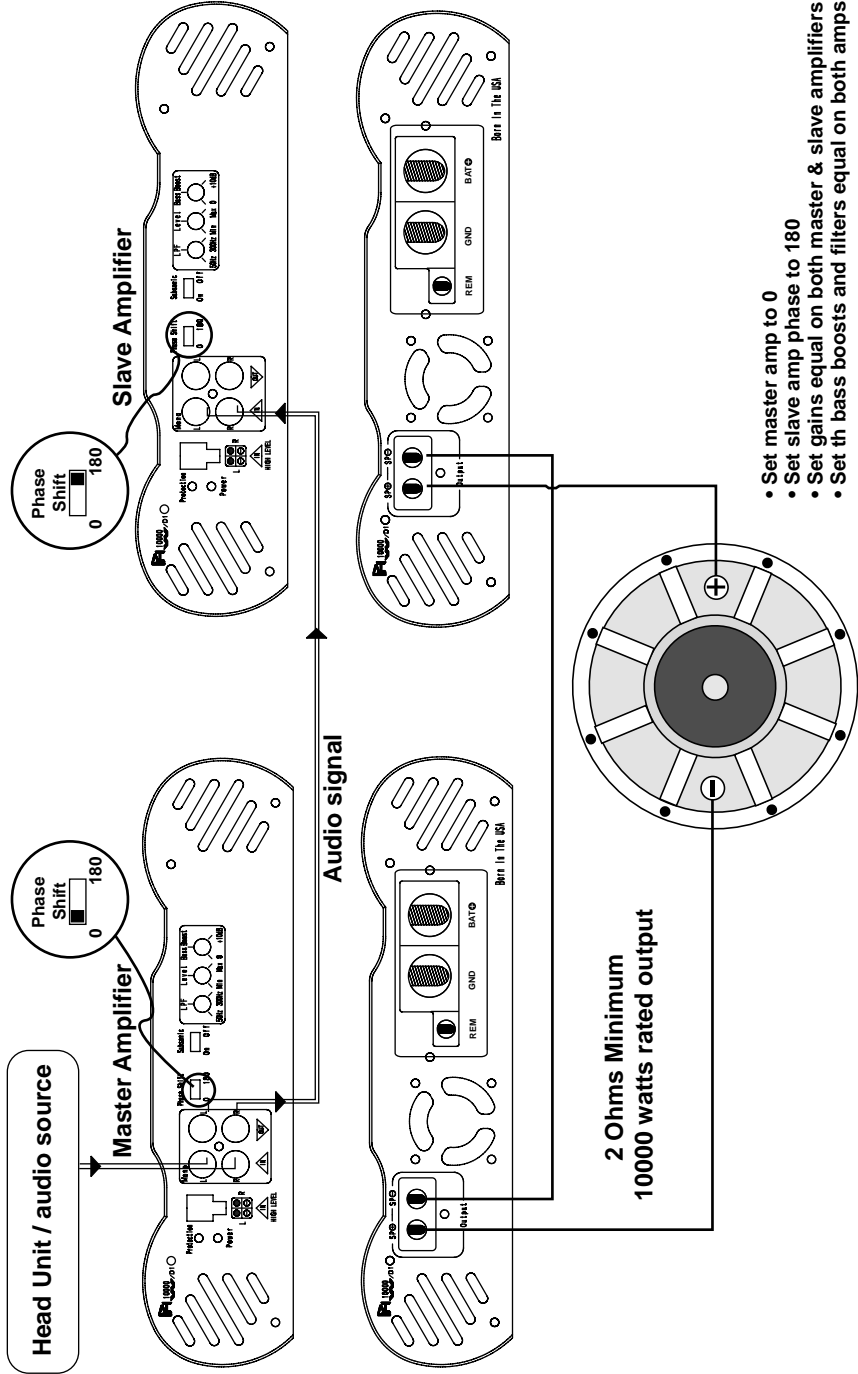

- Set master amp phase to 0
- Set slave amp phase to 180
- Set gains equal on both master & slave amplifiers
- Set th bass boosts and filters equal on both amps

Installation Example

