



MiniMe DSP FF-12



USER MANUAL

Earthquake Sound Corp.
Phone: (510) 732-1000
www.earthquakesound.com
www.earthquakesoundshop.com



Earthquake Sound reserves the right to amend details of the specifications without notice
© Copyright Earthquake Sound Corporation
www.earthquakesound.com
www.earthquakesoundshop.com
2727 McCone Avenue, Hayward, CA 94545 USA
Phone: 510-732-1000

TABLE OF CONTENTS

About Earthquake Sound.....	3
Safety & Handling.....	4-6
Unpacking Your Subwoofer.....	6
Introduction.....	7
What Makes A MiniMe DSP.....	7
Amplifier Plate Overview.....	8-9
Placing Your Subwoofer(s).....	10-11
Connecting Your Subwoofers.....	11-12
Room Tuning With iWoofer™ App.....	13-15
Dimensions And Specifications.....	16
Warranty Information.....	17-18
For Your Records.....	19



WARNING: This product is capable of generating high sound pressure levels. You should exercise caution when operating these speakers. Long term exposure to high levels of sound pressure will cause permanent damage to your hearing. Sound pressure levels exceeding 85dB can be dangerous with constant exposure. Set your audio system to a comfortable loudness level. Earthquake Sound Corp. Does not assume liability for damages resulting from the direct use of Earthquake Sound audio product(s) and urges users to play volume at moderate levels.



The Sound That Will Move You

Earthquake Sound Corporation
2727 McCone Ave. Hayward, CA 94545. USA
Tel: 510-732-1000

© 2021 Earthquake Sound Corporation. All rights reserved.

This document should not be construed as a commitment on the the part of Earthquake Sound Corporation. The information is subject to change without notice. Earthquake Sound Corporation assumes no responsibility for errors that may appear within this document.

FOR YOUR RECORDS

Date of Purchase: _____

Authorized Dealer/Installer Info:

Name: _____

Address: _____

Phone: _____

Serial Number:

Notes:

WARRANTY INFORMATION CONT'D

- Burnt tracers on PCB
- Product/part damaged due to poor packaging or abusive shipping conditions
- Subsequent damage to other products

A warranty claim will not be valid if the warranty registration card is not properly filled & returned to Earthquake with a copy of the sales invoice.

(E) Service Request:

To receive product(s) service, contact Earthquake Sound's service department at (510) 732-1000 or tech@earthquakesound.com and request an RMA (Return Material Authorization) number as item(s) shipped without a valid RMA number will be refused. Make sure you provide us with your complete and correct shipping address, a valid daytime phone number, and a brief description of the problem you are experiencing with the product. In most cases, our technicians might be able to resolve the problem over the phone or via e-mail, thus eliminating the need to ship the product.

(F) Shipping Instructions:

Product(s) must be packaged inside its original protective box(es) to minimize transportation damage. Shipper claims regarding items damaged in transit must be presented to carrier. Earthquake Sound Corporation reserves the right to refuse improperly packaged product(s). A copy of the original sales receipt must accompany the product(s) returned for service. Ship the product(s) to:

Earthquake Sound Corporation. 2727 McCone Avenue. Hayward, CA 94545

The customer is responsible for the cost of shipping the product(s) to Earthquake Sound Corporation

(G) Disputes Resolution:

All disputes - between clients and Earthquake Sound Corporation - resulting from the one (1) year limited warranty policy must be resolved according to the laws & regulations of the county of Alameda, California.

ABOUT EARTHQUAKE SOUND

For over 30 years, Earthquake Sound has been producing a variety of high quality audio products that have impressed audiophile communities around the world. It all started in 1984 when Joseph Sahyoun, a music freak and Aerospace Engineer unhappy with the existing loud speaker technology and performance, decided to put his advance engineering knowledge to use. He pushed technological boundaries to the limit to create the kind of subwoofer he could live with. Earthquake quickly created a name for itself in the car audio industry and became well known for its powerful subwoofers and amplifiers. In 1997, using his existing expertise in the audio industry, Joseph Sahyoun expanded his company to home audio production.

Earthquake Sound has since evolved into a leader in the home audio industry, producing not only subwoofers and amplifiers but surround speakers and tactile transducers as well. Engineered by audiophiles for audiophiles, Earthquake Sound audio products are meticulously crafted to reproduce each and every single note perfectly, bringing your home theater experience to life. With true dedication and full attention to details, Earthquake Sound engineers continuously develop new and better products to meet customers' needs and go beyond their expectations.

From mobile audio to prosound and home audio, Earthquake Sound has been selected as the winner of many prestigious awards based on sound quality, performance, value and features. CEA and numerous publications have awarded Earthquake Sound with over a dozen design and engineering awards. Additionally, Earthquake Sound has been granted many design patents by the USPTO for revolutionary audio designs that have changed the sound of the audio industry.

Headquartered in a 60,000 square foot facility in Hayward, California USA, Earthquake Sound currently exports to over 60 countries worldwide. In 2010, Earthquake Sound expanded its export operations by opening a European warehouse in Denmark. This accomplishment was recognized by the US Department of Commerce who honored Earthquake Sound with an Export Achievement award at the 2011 Consumer Electronic Show. Just recently, the US Department of Commerce presented Earthquake Sound with another Export Achievement award for expanding its export operations in China.



Joseph Sahyoun, US Secretary of Commerce Gary Locke, Abraham Sahyoun and Thomas Myrind



US Commercial Officer Sarah Fox and Joseph Sahyoun



SAFETY INSTRUCTIONS

SAFETY FIRST

This document contains general safety, installation, and operating instructions for the MiniMe DSP subwoofer. It is important to read this user's manual before attempting to use this product. Pay particular attention to the safety instructions.

SYMBOLS EXPLAINED



Appears on the component to indicate the presence of uninsulated, dangerous voltage inside the enclosure - that may be sufficient to constitute a risk of shock.

CAUTION

Calls attention to a procedure, practice, condition or the like that, if not correctly performed or adhered to, could result in injury or death.

WARNING

Calls attention to a procedure, practice, condition or the like that, if not correctly performed or adhered to, could result in damage to or destruction of part or all of the product.

NOTE: Calls attention to information that is essential to highlight.

IMPORTANT SAFETY INSTRUCTIONS

- 1) Read these instructions in their entirety.
- 2) Store this manual and packaging in a safe place.
- 3) Read all warnings.
- 4) Follow instructions (do not take shortcuts).
- 5) Do not use this apparatus near water.
- 6) Clean only with a dry cloth.
- 7) Do not block any ventilation openings. Install in accordance with the manufacturer's instructions.
- 8) Do not install near any heat sources such as radiators, heat registers, stoves, or other apparatuses that produce heat.
- 9) Do not defeat the safety purpose of the polarized or grounding-type plug. A polarized plug has two blades with one wider than the other. The grounding-type plug has two blades and a third grounding prong. The wide blade or the third prong is provided for your safety. If the provided plug does not fit into your outlet, consult an electrician for replacement of the obsolete outlet.
- 10) Protect the power cord from being walked on or pinched, particularly at plugs, convenience receptacles, and the point where they exit from the apparatus.
- 11) Only use attachments and accessories specified by the manufacturer.
- 12) Use only a compatible rack or cart for the final resting position.

4 Specifications are subject to change without notice

WARRANTY INFORMATION

5 YEAR LIMITED WARRANTY INFORMATION

Earthquake Sound warrants the original purchaser that all Factory Sealed New Audio products be free from defects in material and workmanship, under normal and proper use, for a period of **five (5) year from the date of purchase** (as shown on the original sales receipt with serial number affixed/written on it). The one (1) year warranty period is valid only if the product is properly installed by an Earthquake Sound authorized party and the warranty registration card is properly filled out and sent to Earthquake Sound Corporation. If the product is installed by a non-authorized party, a thirty (30) day warranty period applies.

(A) Five (5) year limited warranty guidelines:

- **First Year:** Earthquake pays for labor, parts and ground freight (US Mainland only, not including Alaska and Hawaii.) Shipping to us is not covered.
- **Second, Third, Fourth, & Fifth Year:** Earthquake pays labor only. Customer must pay for parts and freight both ways.

(B) Warning:

- Products (sent for repair) that are tested by Earthquake technicians and deemed to have no problem(s) will not be covered by the limited warranty. Customer will be charged a minimum of one (1) hour of labor (at ongoing rate) plus the shipping charges back to the customer.
- Each product sent in for repair must be packaged in its original packaging. Otherwise, **repackaging charges will apply in addition to the labor, parts, and shipping charges.**

(C) Earthquake agrees to repair or replace - at our discretion - all such defective products/parts subject to the following provisions:

- Defective products/parts have not been altered or repaired by other than an Earthquake factory approved technician.
- Products/parts are not subjected to negligence, misuse, accident, or damaged by improper line voltage.
- Products/parts were used with incompatible products.
- The serial number or any part of the product has been altered, defaced, or removed.
- Products/parts have been used in any way that is contrary to Earthquake's written instructions.

(D) Warranty Limitations:

Earthquake warranty does not cover products that have been modified or abused, including but not limited to the following:

- Damages due to misuse, abuse or use of improper cleaning materials/methods
- Bent speaker frame, broken connectors, hole(s) in speaker cone, hole(s) in surround or dist cap, and burnt speaker voice coil.
- Fading and/or deterioration of speaker components & finish due to improper exposure to elements.

DIMENSIONS AND SPECIFICATIONS - MINIME DSP FF-12

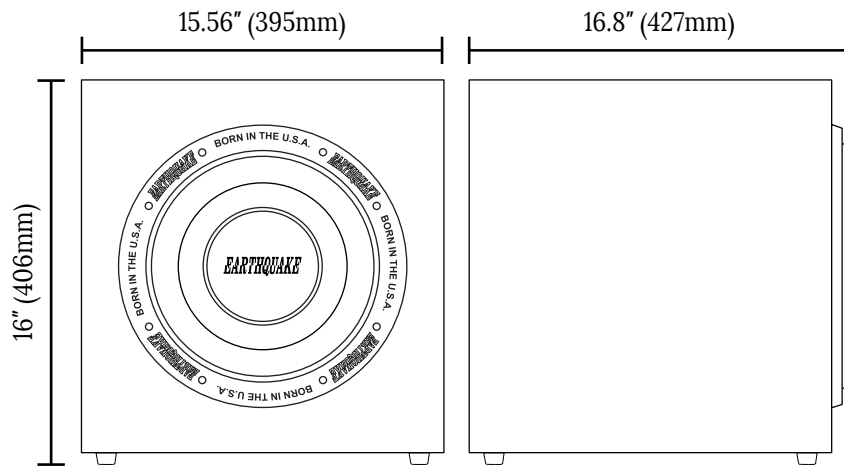

DIMENSIONS INCLUDE AMPLIFIER PROTRUSIONS FEET

ENCLOSURE TYPE	Sealed Front Firing
AMPLIFIER POWER	600 Watts MAX
DRIVERS	12" Long Throw Active Driver
FREQUENCY RESPONSE	18Hz-115Hz
CROSSOVER FREQUENCY	40Hz-160Hz
SIGNAL SENSING	AUTO/ON/OFF
INPUTS/OUTPUTS	Low Level RCA Inputs & Outputs
OTHER FEATURES	Auto Room Tuning Adjustments 0-180° Phase Adjustment Switch IR Remote & Remote Eye 110V/220V AC Selector iWoofers™ Compatible
FUSE RATINGS	110-120V~60Hz: ø5x20, T6.3AL/250V 120-240V~50Hz: ø5x20, T3.15AL/250V
WEIGHT	40 lbs (88 kgs)

SAFETY INSTRUCTIONS CONT'D

- 13) Unplug this apparatus during lightning storms or when unused for a long period of time.
- 14) Refer all servicing to qualified service personnel. Servicing is required when the apparatus has been damaged in a way such as: power-supply cord or plug is damaged, liquid has been spilled or objects have fallen into the apparatus, the apparatus has been exposed to rain or moisture, does not operate normally, or has been dropped.
- 15) To reduce the risk of fire or electric shock, do not expose this apparatus to rain or moisture.

SYSTEM INSTALLATION CONSIDERATIONS

There are several factors to consider before installing or placing Earthquake Sound's MiniMe DSP Subwoofer.

What are the intended listening zones?

From where in each zone will the listener prefer to control the system? Where will the subwoofer be located?

Where will the source equipment be located?

CONNECTION TIPS

- Keep all power cords away from all signal cables to prevent humming from induced noise.
- Choose reliable signal cable cords (Earthquake Sound also specializes in high performance RCA cables and patches).
- All speaker wires that are ran trough the walls should be twisted type to reduce potential hum noise pick-up.
- It is best to use a grounded electrical outlet to power the amplifier. Lack of input ground reference could be unsafe. Consult with your electrical contractor about proper grounding.

SAFE AND PROPER HANDLING

The MiniMe DSP subwoofer is considerably heavy for an average person to carry or maneuver. To prevent injuries and eliminate any possible damage to the subwoofer, we encourage you to employ the help of a friend when unpacking the unit. We further suggest the following.

- wear a back support belt if needed when carrying/lifting the MiniMe DSP FF-12.
- If possible, get someone to help you move the MiniMe DSP FF-12 subwoofer.
- Do not apply pressure or push against the face of the speaker as this will cause irreparable damage to the cone and suspension.

SAFE AND PROPER HANDLING CONT'D

- When carrying the MiniMe DSP, make sure that the speakers/grilles are positioned away from your chest, eliminating the chance of pushing against the face of the speaker.
- Do not drop the MiniME DSP or subject it to sudden shocks. This will damage the external finish and weaken the enclosure, creating air leaks.
- Avoid exposing the MiniMe DSP to moisture. Water will damage the wood structure as well as the amplifier and speaker.
- Cleaning the MiniMe DSP is best using a soft cloth. If needed, use a mild detergent with water. Like any other electrical unit, always make sure that the unit is unplugged prior to cleaning it.

UNPACKING YOUR SUBWOOFER

- Keep the original carton and packing materials for future shipment storage.
- Check for any visual signs of damage. If you encounter any concealed damage, consult your Earthquake Sound dealer before proceeding with unit installation.
- Retain the sales receipt as it establishes the duration of the limited warranty and provides information for insurance purposes.

The MiniMe DSP is packaged well for safety. We highly suggest having a padded surface and at least two (2) people to safely unpack the subwoofer.

STEP 1:

On a padded surface, carefully place the box on its side to remove the bottom packing tape and staples.



STEP 2:

Without tilting the box too much, tug the bottom flaps outward and keep the protective foam in place.



STEP 3:

Gently re-position the box upright.



STEP 4:

Slide the box off, minding the protective foam on the top, bottom, and sides of the subwoofer.



ROOM TUNING WITH iWoofeTM

Room Correction Control

The iWoofeTM Pro app features automatic room correction. To begin select “Room Correction” from the main menu. Once there, select “Wizard” to begin the automatic room correction process. Before beginning, ensure that the gain knob is properly adjusted on the woofer and that the sub is not over-driven.

The iWoofeTM Pro app will begin by taking a near field measurement. Place the microphone as close as possible to the subwoofer and equal distance from the passive side. This can best be done by placing the microphone so that it is facing the side of the subwoofer half-way between the active and passive. After placing your mobile device in the proper location, select “Next” to begin the sweep. It is important to remain as silent as possible during the sweeps. The subwoofer will now sweep through the frequency range. Once completed, you will be asked to add an additional response or sweep measurement or you may continue. Earthquake Sound recommends performing a minimum of 3 response sweeps in order to get an accurate measurement.

Once you have obtained the desired sweeps select “No, Next” to continue to the next step. You will then be prompted to select the reference type for the room compensation, Boomy Region, Near Field or Linear. We recommend the “Boomy Region” selection since it maintains the high energy peaks of the low frequencies while creating a linear response for the mid range. The Near Field option is ideal for users with poor mic tolerance as it measures relative SPL and only com-

pensates for the room reflection and not the woofer/box itself. The final reference, Linear, creates as flat as a response curve as possible throughout the frequency range.

After the desired option is selected, iWoofeTM will then instruct you to place the mic in your typical listening position. Once the mic is placed, click “Next”. The iWoofeTM Pro app will then proceed to sweep again. As before, we recommend performing at least 3 response sweeps. Click “No, Next” when you have concluded your response sweeps and iWoofeTM will proceed to make the necessary adjustments to your subwoofer’s response.

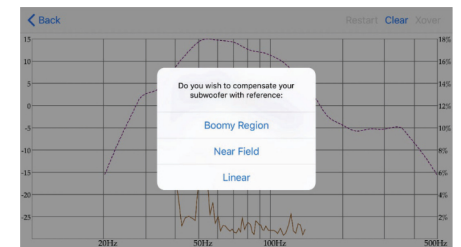
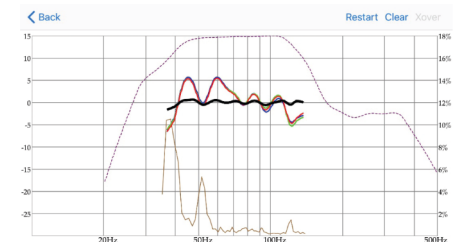
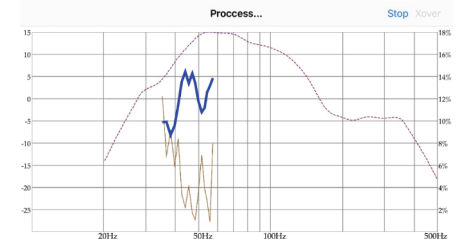

ROOM TUNING WITH iWoofer™

Main Menu Cont'd

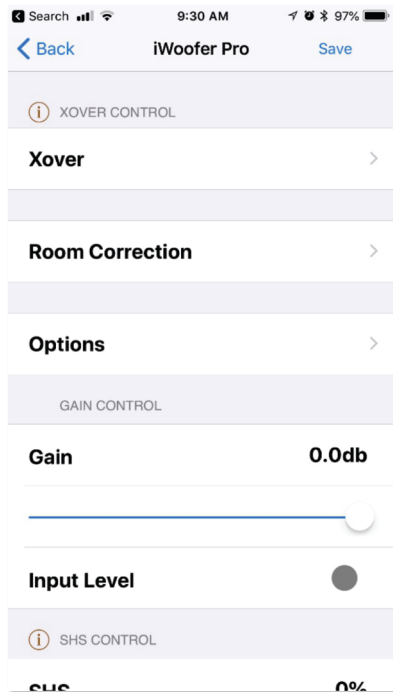

Xover Control

The XOver or Crossover control allows the user to control both the Low Pass and High Pass filters by double tapping the curve, or pressing and holding it for more than 1 second. The curve can then be slid left to right to control the frequency from 20Hz up to 500Hz. The curve can also be slid up and down to control the order of the filter up to an 8th order or 48 db/oct filter.

To add a fully Parametric Equalizer (PEQ), select the “+” icon. Up to 25 bands can be added, to remove a band select the trash icon. Double tap or press and hold a band for more than

one second to select it. Once selected, slide the band left or right to change the frequency and up and down to control the gain. You can also use two fingers in a zoom in or zoom out fashion to change the Q factor, or PEQ bandwidth.

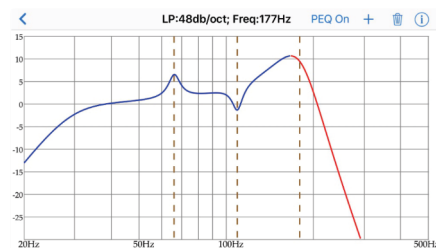
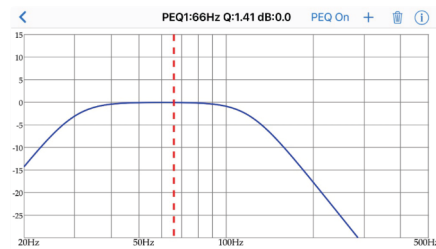
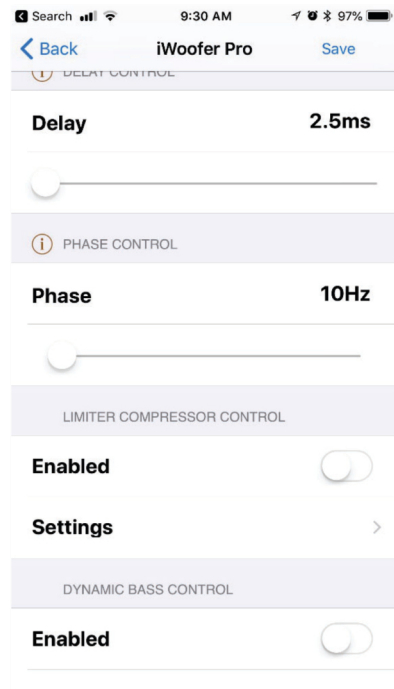

INTRODUCTION

Congratulations on your choice of Earthquake Sound's MiniMe DSP series of subwoofers. MiniMe DSP subwoofers were designed to dramatically enhance your enjoyment of music and movies at home by adding power and impact to low frequency sound effects without taking up your entire living space. Congratulations and thank you for choosing the Earthquake MiniMe DSP as a key component of your home audio system.

MiniMe DSP subwoofers utilize an advanced digital class “D” amplifier, a premium long throw active driver with a durable black polyurethane enclosure that MiniMe delivers phenomenal bass. The all new iWoofer™ interface allows for automatic professional room tuning for full control of the DSP from a mobile device.

Designed in the U.S.A., The MiniMe DSP series of subwoofers meet and exceed industry standards of performance and quality. With compromised “World Class” performance and superior technology, MiniMe DSP subwoofers embody both power and elegance.

WHAT MAKES A MINIME DSP

Digital Class “D” Amplifier

The MiniMe DSP amplifier utilizes an advanced class “D” circuitry with over 90% efficiency, allowing it to perform continuously without getting hot. The 600 watts peak power amplifier is fully equipped with IR inputs, auto room tuning adjustments, 0–180° phase switches, low level RCA inputs & outputs, auto signal sensing, and iWoofer™ app controlled DSP module.

Premium Long Throw Drivers

The active driver installed in every MiniMe DSP P-15 and FF-15 is specifically designed for accurate reproduction of bass and sub-bass frequencies. Built with TCT (Turbine Cooled Transducer) technology, stitched tensile leads, anti-wobble cone construction, and reinforced dust cap, the MiniMe DSP driver effortlessly produces phenomenal bass with extremely low distortion while staying cool.

Polyurethane Finished Cabinet

The cabinet is CNC cut to precision and begins with a thorough sanding and priming and finished with a durable black polyurethane spray texture.

IN THE BOX

- (1) MiniMe DSP FF-12 subwoofer
- (1) Subwoofer power cable
- (1) IR remote
- (1) IR remote eye

AMPLIFIER PLATE OVERVIEW

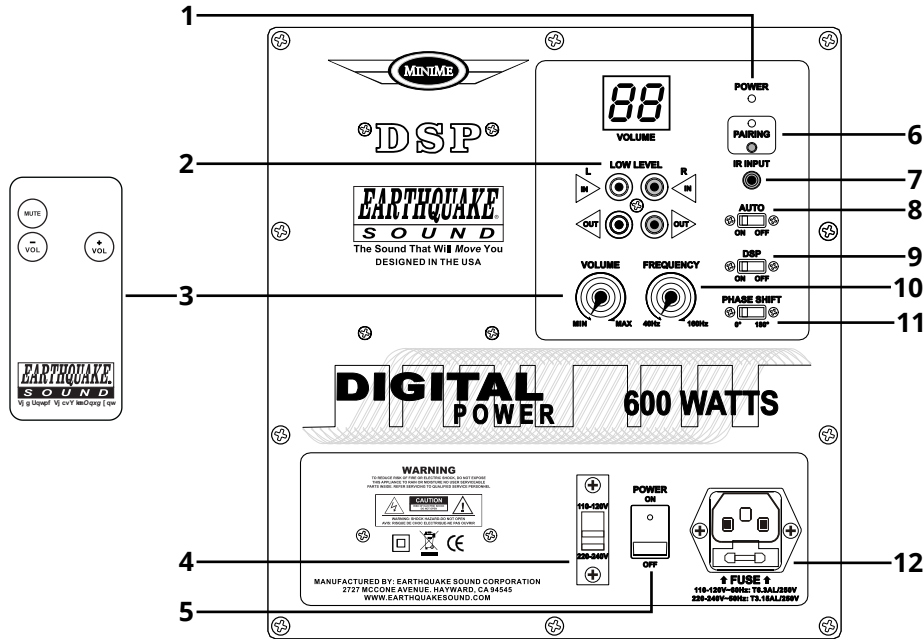

(1) LED Power Signal Indicator

This LED indicator reflects the main power status of the amplifier as well as the state of the amplifier (whether the AUTO Sensing is on/off and whether signal is being fed to the amplifier). Note that this LED will only light up when the main power switch is in the ON position.

(2) Low Level RCA Input/Output

Used this input to deliver an audio signal from your A/V source to the MiniMe DSP FF-12 amplifier.

(3) Volume Control

Remote buttons and knob allow the user to control the volume of the subwoofer. Always start at the lowest setting and slowly increase the volume until the desired subwoofer level is reached. Use the MUTE button on the remote to mute or un-mute.

Signal Sensing	Is There Signal?	LED Color
ON	Yes	Green
	No	Green
AUTO	Yes	Green
	No	Red
OFF	Yes	Red
	No	Red

(4) 110V/220V AV Selector

The MiniMe DSP FF-12 can operate in both 110-120V or 220-240V environments. slide the selector to your required power setting and replace the fuse to the correct power rating prior to connecting the subwoofer to any power sources.

(5) Power Switch

Used to turn the MiniMe DSP amplifier power on or off. Set this switch to the ON position in order to use the AUTO ON function.

ROOM TUNING WITH iWoofeTM

About iWoofeTM

iWoofeTM is a mobile based application developed by ARTEM KHLIUPIN, that allows the user to control DSP settings from a mobile device. In addition to full DSP control, the iWoofeTM Pro app offers automatic room correction to achieve a more linear or boomy response from the woofer.

Getting Started

Launch the iWoofeTM or iWoofeTM Pro app on your mobile device. Ensure that the iWoofe supported subwoofer is powered on and that Bluetooth is enabled on your mobile device. There is no need to search for the Bluetooth signal, the iWoofeTM app will automatically find it. Once the application has been launched, a list of devices found will appear as shown in the image. The device name is generally a string of letters and numbers representing the unique MAC or UDID address of the woofer you are connecting to. Alternatively, the “Demo Mode” can be used to test the iWoofeTM features without connecting to a woofer.

After selecting your device, you will be prompted to import a DSP preset. If no previous presets have been saved on the woofer, select “Cancel” to continue connecting, otherwise select “OK”. Your mobile device will now connect with the woofer. Once connected, the device can be renamed from the “Options” menu.

Main Menu

Once connected, the iWoofeTM application will automatically take you into the main menu. The iWoofeTM menu features and options are listed.

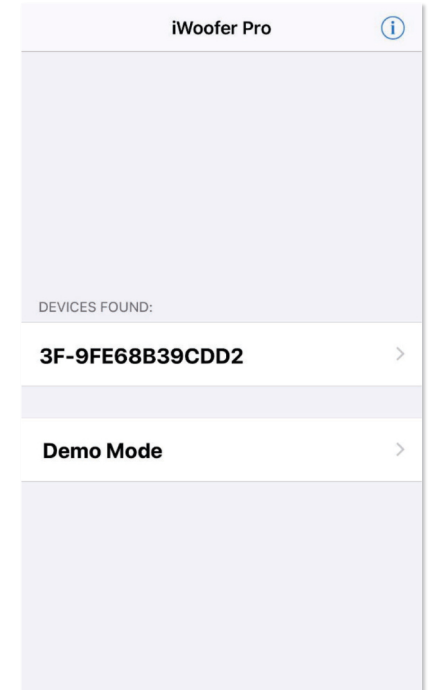

- XOver Control
- Gain Control
- SHS Control
- Delay Control
- Phase Control
- Limiter-Compressor Base Control
- Limiter-Compressor Detailed Control*
- Dynamic Bass Base Control
- Dynamic Bass Detailed Control*
- Remote Hardware Control
- Preset Manager
- Preset Import/Export Features
- Room Correction*
- SPL Meter*

*iWoofe Pro Features Only

LOW LEVEL SETUP - DUAL SUBS

For a more realistic sound stage and greater theater experience, we suggest having two (2) subwoofers and running them in stereo.

Using a “Y” RCA cable, connect the SUB PRE OUT 1 of the receiver to the LOW LEVEL INPUT of the left side MiniMe DSP FF-12.

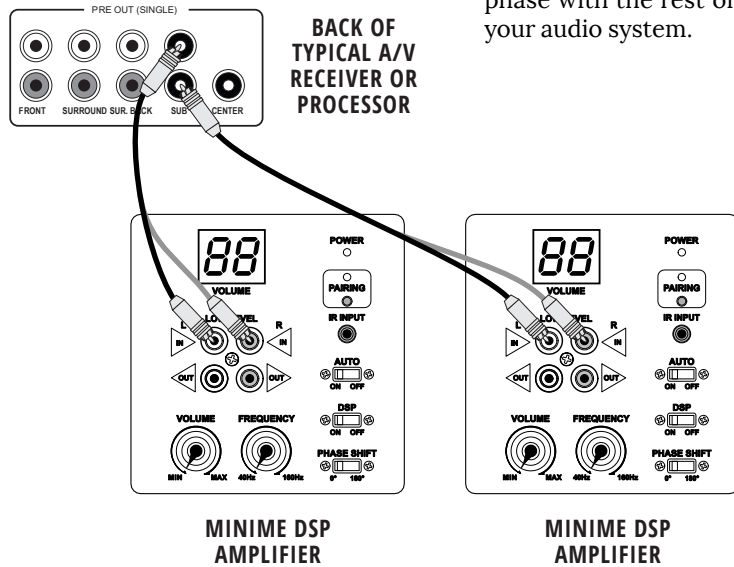

Using another “Y” RCA cable, connect the SUB PRE OUT 1 of the receiver to the LOW LEVEL INPUT of the right side MiniMe DSP FF-12.

In case the subwoofers become out of phase with the main front speakers, flip the phase switches to correct the problem. Note that maximum bass is only achieved when the subwoofer is in phase with the rest of the speakers in your audio system.

AMPLIFIER PLATE OVERVIEW CONT'D

(6) DSP Pairing

Use this button to pair a mobile device via Bluetooth[®] or for factory resetting iWoofers™. To lock password press and hold for 3 seconds.

(7) IR Input

Used to control the amplifier using the included remote control. Simply plug the remote eye in the IR INPUT.

(8) Auto/On/Off Mode Selector

This is a 3-way switch. When ON, the amplifier will remain on regardless of signal presence. When set to AUTO, the amplifier will only turn on when audio signal is detected. Additionally, the amplifier will go to sleep/standby if it does not detect any signal after 15 minutes. When set to OFF, the amplifier will remain off regardless of signal presence. Note that the MAIN POWER switch must be in the ON position in order for this feature to work.

(9) DSP On/Off Selector

This switch is used to enable or disable the application controlled DSP. When set to the OFF position, the frequency adjustment knob will be active allowing the user to make manual adjustments.

(10) Low Pass Filter

This variable low pass filter from 40–160Hz is designed to control the subwoofer’s cutoff frequency. Any Signals above the set crossover frequency will gradually roll off to prevent from interfering with your surround speakers.

(11) Phase Shift Selector

This 0–180° switch allows the user to synchronize the subwoofer to obtain a better and more precise bass response.

(12) AC POWER INPUT WITH BUILT-IN FUSE

The AC line connector is fused to protect the subwoofer from unwanted power surges. Make sure to use the proper fuse rating when replacing the fuse. To access the fuse compartment, simply unplug the subwoofer from any power sources and place a flat-head screw driver in the small notch and pry it open as illustrated below.

110-120V~60Hz:ø5x20mm, T6.3AL/250V
220-240V~50Hz:ø5x20mm, T3.15AL/250V

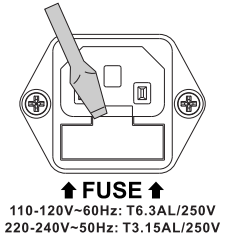

↑ FUSE ↑
110-120V~60Hz: T6.3AL/250V
220-240V~50Hz: T3.15AL/250V

PLACING YOUR SUBWOOFER(S)

You often hear the term “subwoofers are non-directional.” This is not true. It is harder to choose subwoofer placement when low frequencies are crossed. The wider the room, the more directional the subwoofer. The easiest solution is to use two (2) subwoofers, feed a mono signal to both and place them in front, one on the left and another on the right.

While having two (2) subs is better than one, the MONO signal that drives those subs keeps them from projecting the three dimensional images in the sub-harmonics. Using two (2) subwoofers allows you to cross the subs up to 250Hz sound quality, imaging and staging. In some applications, you might have small front speakers or planar speakers. The two front-subwoofer system is an excellent solution to planar speakers’ low frequency response early roll off from 150Hz on down. When placing these subwoofers in close proximity to the stereo satellite, the subs will enhance low frequency extension. It will be better to have a stereo subwoofer to help in the lower bass notes and their placement.

Suppose you have only one (1) subwoofer in the room and it is placed on the right side of the room. If a bass guitar player was standing on the left side of the stage and played a EE note (42Hz), then the sub will also respond to that from the right side of the room and completely destroy the stage.

You will see illustrations showing the two (2) different suggested setups. In each of them, note the breakaway and the image separation represented by the black and gray arrows.

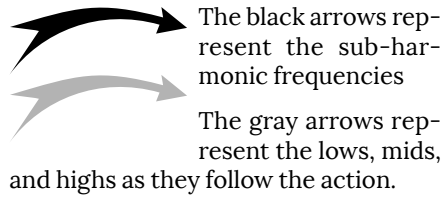

The best response is achieved when the subharmonic frequencies are dynamically synchronized with the rest of the audio system, the black and gray arrows are identical.

SINGLE SUBWOOFER SETUP

This is a GOOD setup. The subharmonic frequencies (black arrow) always move towards the sub in the single sub setup while the lows, mids, and highs (gray arrow) follow the action.

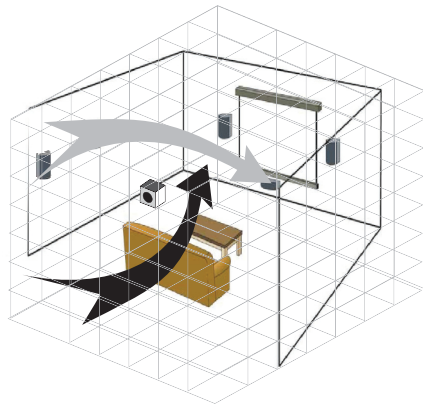

Placing the subwoofer in the corner of the room will produce a more boomy effect, often preferred for movies and sound tracks. For a music application, place the subwoofer as show above or against the front wall, about a third of the room width.

PLACING YOUR SUBWOOFER(S)

DUAL SUB SETUP WITH MONO SIGNAL

This is a BETTER setup. In a dual subwoofer setup, the sub-harmonic frequencies (black arrow) always move towards the middle of the room while the lows, mids, and highs follow the action (gray arrow).

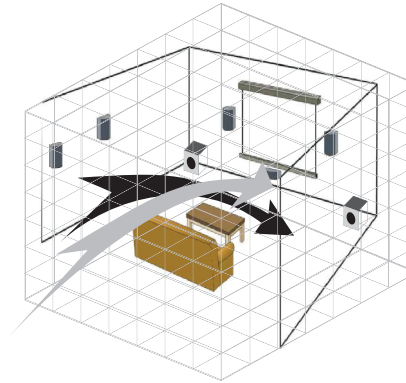

Notice the breakaway and image separation is less in this setup than the single subwoofer setup.

CONNECTING THE MINIME DSP

LOW LEVEL SETUP - SINGLE SUB

This is the best way to drive an audio signal to your MiniMe DSP FF-12 subwoofer. Today, all signal processors (5.1, 6.1, etc.) come equipped with built-in pre-amplifier outputs (RCA) that include a subwoofer output. Generally, the SUB PRE OUT is in a mono format. Connect the SUB PRE OUT from your audio/video processor to the MiniMe DSP FF-12 LOW LEVEL INPUT using a “Y” RCA cable.

We strongly recommend that you use the best available RCA connectors and cables. Most high quality RCA cables are triple shielded and the connectors are gold plated with forceful grasping.

When using this connection, the MiniMe DSP P10/P12 only receives bass signals from the source. Therefore, the crossover frequency should be set at max value.

