

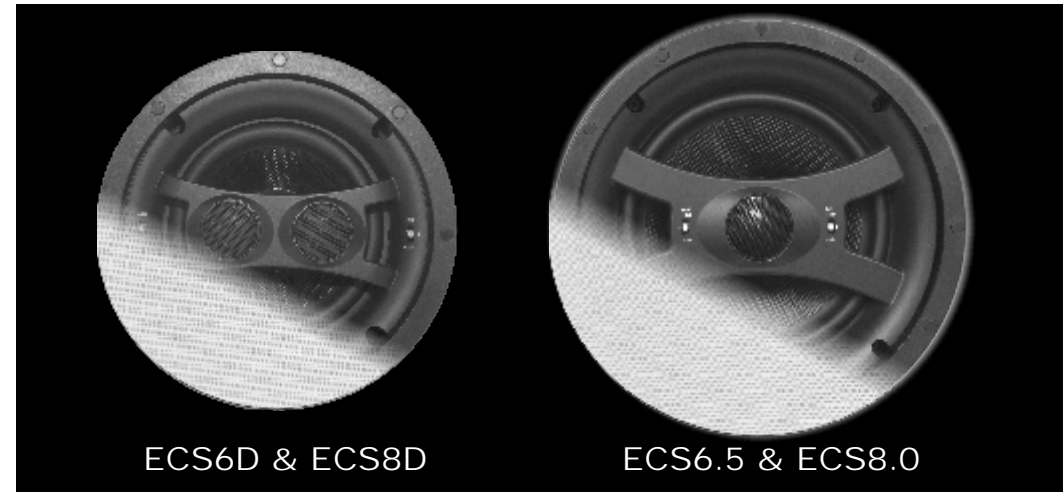

ECS

Edgeless High Fidelity In-Ceiling Speaker Series



Earthquake Sound reserves the right to amend details of the specifications without notice.
Copyright © Earthquake Sound Corporation
Earthquake Sound Corporation • 2727 McCone Avenue Hayward CA, 94545
Phone: 510-732-1000 Fax: 510-732-1095

Installation Manual

www.earthquakesound.com

The Sound That Will Move You



CAUTION

Calls attention to a procedure, practice, condition or the like that, if not correctly performed or adhered to, could result in injury or death.

WARNING

Calls attention to a procedure, practice, condition or the like that, if not correctly performed or adhered to, could result in damage to or destruction of part or all of the product.



WARNING: These products are capable of generating high sound pressure levels. You should exercise caution when operating these speakers. Long term exposures to high levels of sound pressure will cause permanent damage to your hearing. Sound pressure levels exceeding 85dB can be dangerous with constant exposure, set your audio system to a comfortable loudness level. Earthquake Sound Corporation does not assume liability for damages resulting from the direct use of Earthquake speakers, and urges users to play volume at moderate levels.

This document should not be construed as a commitment on the part of Earthquake Sound Corporation. The information is subject to change without notice. Earthquake Sound Corporation assumes no responsibility for errors that may appear within this document.

Dear Valued Customer,

Thank you for purchasing the ECS, Edgeless Series of In-Ceiling Speakers; one of Earthquake Sound's most valued in-Ceiling speaker lines. Designed with aesthetics and sound quality in mind, the ECS seamlessly blends into its surrounding as it provides a lifetime of durability and high-end performance.

It is very important to read and follow all installation/mounting instructions and recommendations in this manual thoroughly to ensure optimal performance and longevity.



Earthquake Sound Corporation
2727 McCone Avenue
Hayward, CA 94545
Tel: 510-732-1000
Fax: 510-732-1095

Customer Support
tech@earthquakesound.com
Tel: 800-576-7944
Fax: 510-732-1095



The Edgeless In-Ceiling speakers are designed for use in any space like bedrooms, living rooms, kitchens, etc... Each features a single 1" Neo tweeter and a long excursion woofer. The ECS seamlessly blend into surrounding as they provide a lifetime of durability and high-end performance.

The ECS Features

- » Frameless design for reduced visibility/low profile/seamless blend
- » Long excursion kevlar woofer cones
- » One 1" (25mm) silk dome NEO swiveling tweeter
- » ± 3dB bass and treble controls
- » Elaborate crossover networks with polyswitch protection
- » Easy Turn-N-Lock™ installation mechanism
- » Gold plated, spring loaded terminals
- » Magnetically attached, paintable grilles

ECS6.5 & ECS8.0



The Edgeless In-Ceiling Dual speakers are designed for use in limited/small spaces like bathrooms, kitchens, corridors, etc... They feature dual tweeters and dual woofer voice coils (2 speakers in 1): one ECSD is capable of reproducing a stereo signal; thus eliminating the need to use two speakers.

The ECSD Features

- » Frameless design for reduced visibility/low profile/seamless blend
- » Long excursion kevlar woofer cones
- » Two 1" (25mm) silk dome NEO swiveling tweeters
- » Dual voice coil woofer
- » ± 3dB bass and treble controls
- » Dipole / Bipole modes
- » Surround / DVC modes
- » Elaborate crossover networks with polyswitch protection
- » Easy Turn-N-Lock™ installation mechanism
- » Gold plated, spring loaded terminals
- » Magnetically attached, paintable grilles

ECSD6 & ECSD8



The ECS6D is equipped with two (2) switches: the **Bipole/Dipole** switch and the **Surround/DVC** switch. The two switches work independently, they are used to customize the ECS6D performance for different applications.

In **Dipole mode**, the speaker is in STEREO mode (2 speakers in 1). The two terminals are totally independent (2 separate inputs, using both terminals). Each terminal has an impedance of 8-Ohm. The speaker can be set in Surround or in DVC mode depending on the listener preferences. In **Bipole mode**, the speaker is in MONO mode. The two terminals are internally connected in parallel (1 input needed, using only one terminal). The total speaker impedance is 4-Ohm. Again, the speaker can be set in Surround or in DVC mode depending on the listener preferences.

In **DVC mode**, the speaker exhibits higher level of details & separation between L & R channels. The **Surround mode** gives the speaker response more surround feeling, deeper warmer bass & more blending between L & R channels.

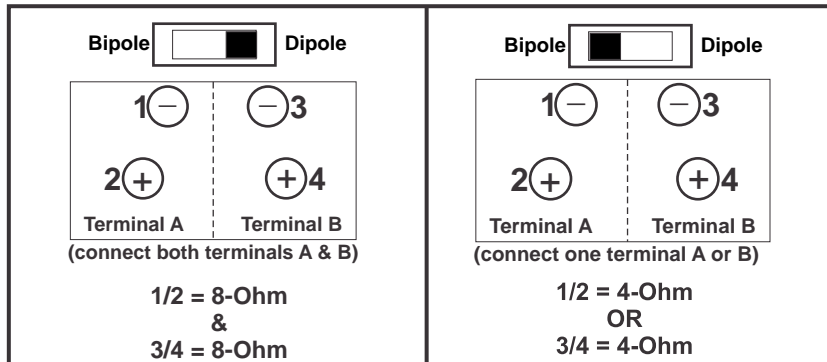

High Definition Stereo application using one (1) ECS6D:

- Set switch #1 in Dipole mode
- Set switch #2 in DVC mode
- Impedance 8-Ohm per terminal
- Connect both terminals A & B separately (2 separate inputs / left & right)

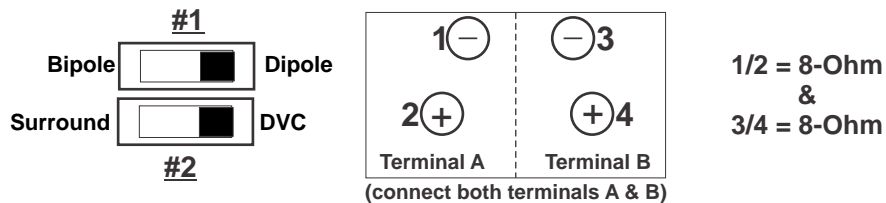

Surround Effect Stereo application using one (1) ECS6D:

- Set switch #1 in Dipole mode
- Set switch #2 in Surround mode
- Impedance 8-Ohm per terminal
- Connect both terminals A & B separately (2 separate inputs / left & right)

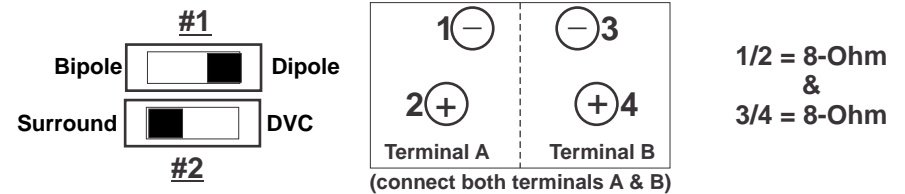

Mono application using one (1) ECS6D:

- Set switch #1 in Bipole mode
- Set switch #2 in DVC mode
- Total impedance 4-Ohm
- Connect one (1) terminal A OR B (1 input)

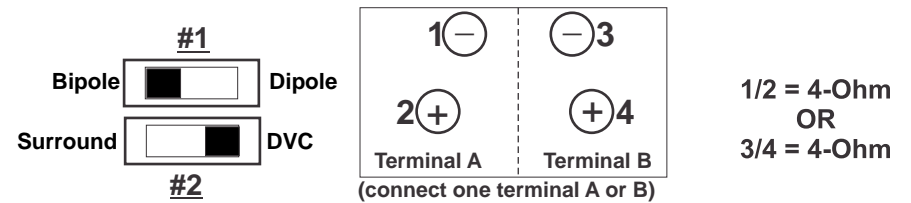

Surround Effect Mono application using one (1) ECS6D:

- Set switch #1 in Bipole mode
- Set switch #2 in Surround mode
- Total impedance 4-Ohm
- Connect one (1) terminal A OR B (1 input)

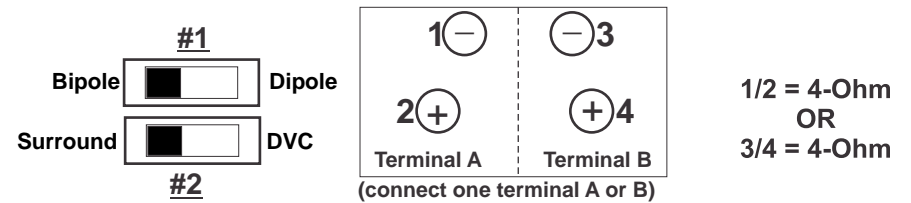

The ECS8D is equipped with two (2) switches: the **Bipole/Dipole** switch and the **Surround/DVC** switch. The two switches work independently, they are used to customize the ECS6D performance for different applications.

In **Dipole mode**, the speaker is in STEREO mode (2 speakers in 1). The two terminals are totally independent (2 separate inputs, using both terminals). Each terminal has an impedance of 8-Ohm. The speaker can be set in Surround or in DVC mode depending on the listener preferences. In **Bipole mode**, the speaker is in MONO mode. The two terminals are internally connected in parallel (1 input needed, using only one terminal). The total speaker impedance is 4-Ohm. Again, the speaker can be set in Surround or in DVC mode depending on the listener preferences.

In **DVC mode**, the speaker exhibits higher level of details & separation between L & R channels. The **Surround mode** gives the speaker response more surround feeling, deeper warmer bass & more blending between L & R channels.

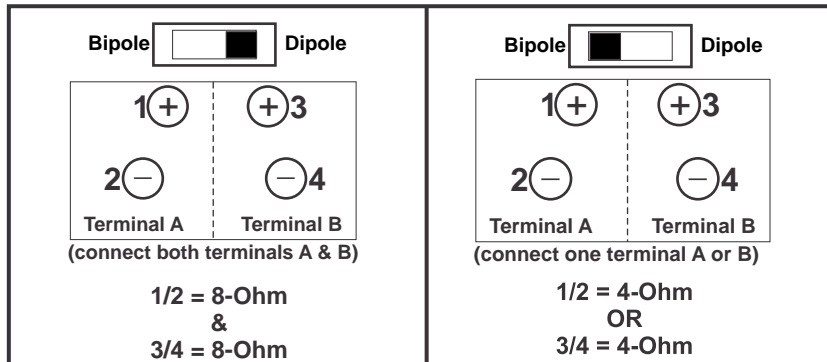
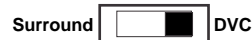

High Definition Stereo application using one (1) ECS8D:

- Set switch #1 in Dipole mode
- Set switch #2 in DVC mode
- Impedance 8-Ohm per terminal
- Connect both terminals A & B separately (2 separate inputs / left & right)

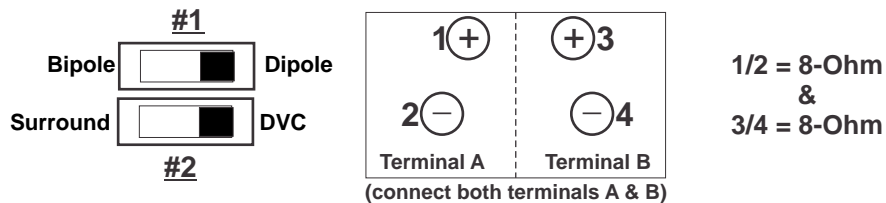

Surround Effect Stereo application using one (1) ECS8D:

- Set switch #1 in Dipole mode
- Set switch #2 in Surround mode
- Impedance 8-Ohm per terminal
- Connect both terminals A & B separately (2 separate inputs / left & right)

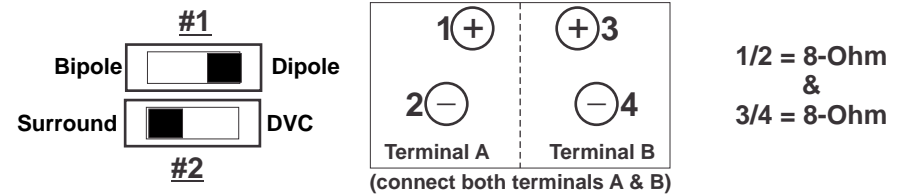

Mono application using one (1) ECS8D:

- Set switch #1 in Bipole mode
- Set switch #2 in DVC mode
- Total impedance 4-Ohm
- Connect one (1) terminal A OR B (1 input)

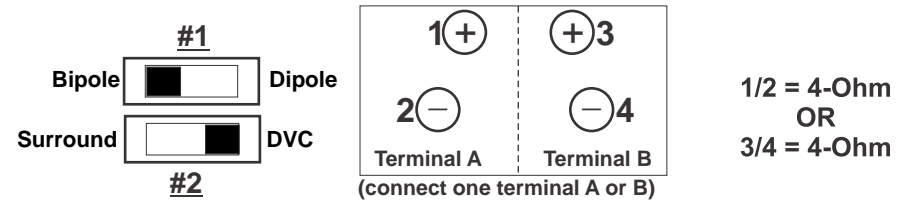

Surround Effect Mono application using one (1) ECS8D:

- Set switch #1 in Bipole mode
- Set switch #2 in Surround mode
- Total impedance 4-Ohm
- Connect one (1) terminal A OR B (1 input)

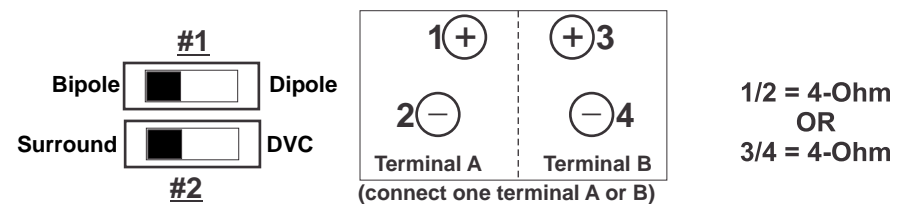

Speaker Placement

The ECS Edgeless In-Ceiling Speakers are designed to be flush mounted in walls or ceilings. For optimal acoustical performance, simply follow these guidelines:

1. Place speakers at an equal distance (left/right) from listener.
2. Speakers must be spaced at a 40 - 60° angle from listener (Figure 1).
3. Aim tweeter towards the listener's ear when in listening position.

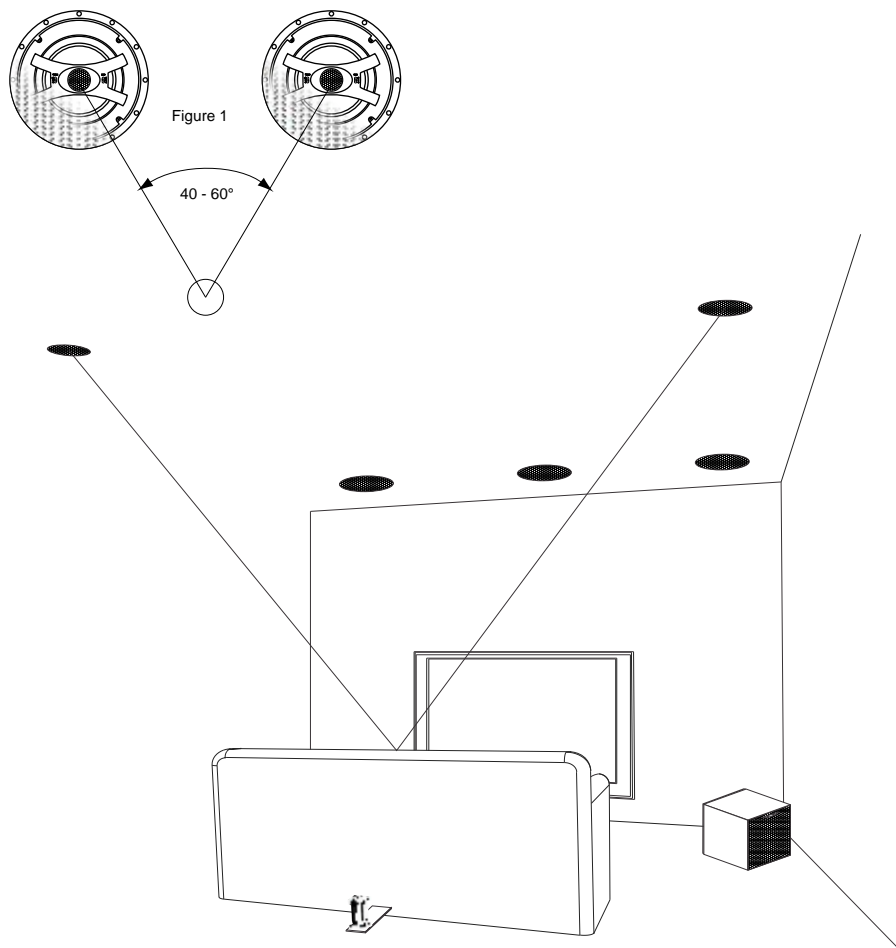

1 Cut the hole:
using the provided
cut out template



2 Wire the speaker:
using the non-obtrusive
spring-loaded speaker
terminals



3 Mount the speaker:
by utilizing the
Turn-N-Lock™
installation mechanisms



Simply tighten the screws by hand **using a screwdriver** to prevent the mounting ears from snapping. Some resistance may occur the first few turns of the screw as it makes its path through the plastic.

Grille Painting Guidelines

The ECS Edgeless In-Ceiling Speaker grilles are paintable and can accept virtually any type of paint. We strongly recommend the following:

1. Remove the grilles from the speakers prior to painting them.
2. Thin the paint prior to application, if needed. Spray and roller paint applications typically provide the best results. Note that you may need to apply **multiple thin layers** of paint to achieve the desired shade without losing sound quality due to clogging of the grilles.
3. Let the painted grilles fully dry before mounting them back on the speakers.

ECS6.5 SPECIFICATIONS

Frequency Response:	40Hz - 20kHz
Sensitivity:	87dB @ 1W/1M
Nominal Impedance:	8-Ohm
Power Handling:	300 Watts Max
Enclosure Material / Type:	Impact resist ABS Plastic
Driver Components:	Two-way system using: one 6.5" low mass stiff kevlar cone midbass and one 1" silk dome swiveling NEO tweeter
Outer Diameter:	8 9/16" (223mm)
Cut Out Diameter:	7 7/8" (200mm)
Mounting Depth:	4 5/16" (110mm)
Wire Gauge Recommended:	12
Weight Per Speaker:	3.9 lbs
Grille Finish:	White / Paintable

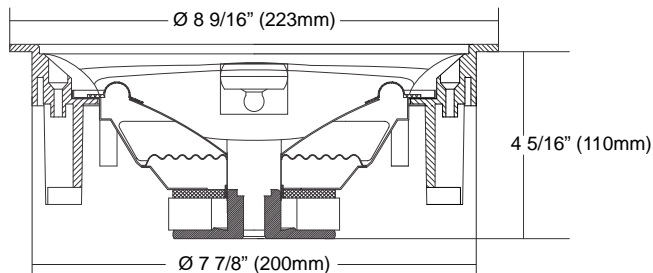

ECS8.0 SPECIFICATIONS

Frequency Response:	30Hz - 20kHz
Sensitivity:	88dB @ 1W/1M
Nominal Impedance:	8-Ohm
Power Handling:	400 Watts Max
Enclosure Material / Type:	Impact resist ABS plastic
Driver Components:	Two-way system using: one 8" low mass stiff kevlar cone midbass and one 1" silk dome swiveling NEO tweeter
Outer Diameter:	10 1/2" (267mm)
Cut Out Diameter:	9 1/2" (242mm)
Mounting Depth:	4 7/8" (124mm)
Wire Gauge Recommended:	12
Weight Per Speaker:	4.3 lbs
Grille Finish:	White / Paintable

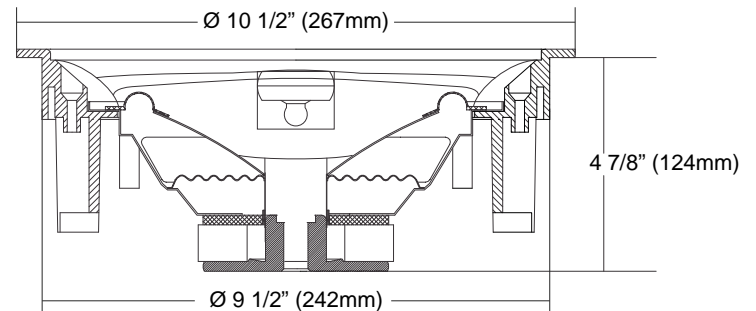

ECS6D SPECIFICATIONS

Frequency Response:	40Hz - 20kHz
Sensitivity:	87dB @ 1W/1M
Nominal Impedance:	8-Ohm In Dipole Mode 4-Ohm In Bipole Mode
Power Handling:	350 Watts Max
Enclosure Material / Type:	Impact resist ABS Plastic
Driver Components:	Two-way system using: one 6.5" low mass stiff kevlar cone midbass and two 1" silk dome swiveling NEO tweeters
Outer Diameter:	8 9/16" (223mm)
Cut Out Diameter:	7 7/8" (200mm)
Mounting Depth:	4 5/16" (110mm)
Wire Gauge Recommended:	12
Weight Per Speaker:	4 lbs
Grille Finish:	White / Paintable

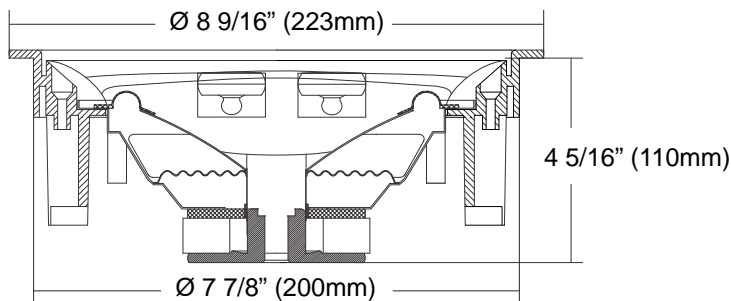

ECS8D SPECIFICATIONS

Frequency Response:	30Hz - 20kHz
Sensitivity:	88dB @ 1W/1M
Nominal Impedance:	8-Ohm In Dipole Mode 4-Ohm In Bipole Mode
Power Handling:	450 Watts Max
Enclosure Material / Type:	Impact resist ABS plastic
Driver Components:	Two-way system using: one 8" low mass stiff kevlar cone midbass and two 1" silk dome swiveling NEO tweeters
Outer Diameter:	10 1/2" (267mm)
Cut Out Diameter:	9 1/2" (242mm)
Mounting Depth:	4 7/8" (124mm)
Wire Gauge Recommended:	12
Weight Per Speaker:	4.5 lbs
Grille Finish:	White / Paintable

