



EARTHQUAKE HOME THEATER

EARTHQUAKE
SOUND
The Sound That Will Move You

EARTHQUAKE®

Engineered by audiophiles for audiophiles, Earthquake Sound's amplifiers and speakers are meticulously crafted to reproduce each and every single note perfectly, bringing your home theater experience to life. With true dedication and full attention to details, our engineers continuously develop new and better products to meet consumers' needs and go beyond their expectations.

Earthquake has a wide range of products for all audiophile needs and continues to grow and formulate innovative audio solutions. Earthquake has evolved into a leader of the home audio industry, producing not only subwoofers and amplifiers but surround speakers, tactile transducers and WiFi modules as well. Earthquake Sound can provide audio solutions in every room, whether in your home theater, outdoors, or just in the background.

At Earthquake Sound, we strive to design and engineer the most powerful and reliable products possible while providing these high-end solutions at every price point.

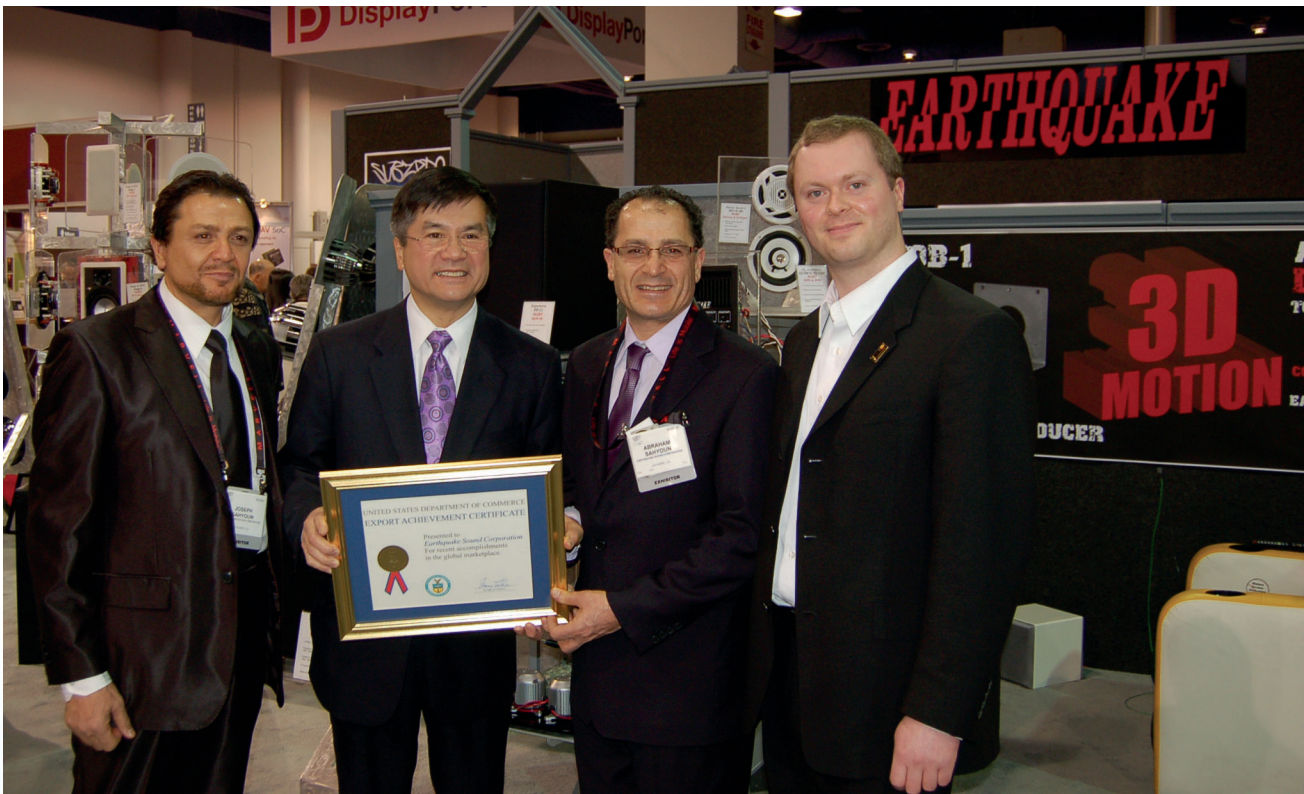

EXPORT ACHIEVEMENT

The United States Secretary of Commerce Gary Locke honored Earthquake Sound with an export achievement award for recent accomplishments in the global market place at the Consumer Electronics Show. Joseph Sahyoun (founder of Earthquake Sound Corporation) and Abraham Sahyoun (Export Manager) were grateful for the opportunity to briefly discuss important business developments with the secretary. The US Department of Commerce recognized Thomas Mygind, President of Earthquake Europe for his achievement in expanding export operations thus creating more American jobs.

Earthquake Sound Corporation has a strong and fruitful relationship with the US Department of Commerce and appreciates their continued assistance in expanding global sales operations.



HISTORY

For over 30 years, Earthquake Sound has produced a variety of high quality audio products that have impressed audiophile communities around the world. In 1997, using his existing expertise in the audio industry, Joseph Sahyoun expanded his company to home audio production. From mobile audio to prosound and home audio, Earthquake Sound has been selected as the winner of many prestigious awards based on sound quality, performance, value and features.

We look forward to continuing to manufacture in this evolving market while further expanding in even more diverse industries and audiences.

AWARDS



Over the years, CEA and numerous publications have awarded Earthquake Sound with over a dozen design and engineering awards. Additionally, Earthquake has been granted many design patents by the USPO for revolutionary audio designs that have changed the sound of the audio industry.

TITAN TELESTO



THE TITANS

The new generation of Titans is the result of five years of intensive development and the natural continuation of the research that began nearly 25 years ago with Joseph Sahyoun's dream of the perfect loudspeaker. During the development of the original reference, the Titan Tethys, it was recognized that the combination of individually uncompromising components failed to achieve the homogeneous perfection and true to life reproduction Joseph so ardently desired.

New units were developed in-parallel and designed to work harmoniously together. Closely mimicking nature's organic growth, the drive units grew up together instead of being introduced to each other as adult strangers, attempting to connect through a complex diluting crossover network. The result is a loudspeaker with constant energy dispersion. A speaker with no tonal shift regardless of volume. A speaker where detail is not achieved at the expense of dynamics.

Titan Series' straight through, wide open performance sets a new standard for loudspeaker design.

**"WHEN YOU CAN GET
MUSIC TO SOUND LIKE THIS,
IT JUST MAKES ONE'S HAIR
STAND ON END."**

Dr. John E. Johnson Jr. PHD,
Secrets of Home Theater and
High Fidelity

CORE EARTHQUAKE TECHNOLOGIES
FEATURED IN THIS PRODUCT



TITAN TIGRIS



HEMI ELLIPTICAL CABINET TECHNOLOGY

The Hemi Elliptical design reduces reflections and standing waves which ensures a transparent, dynamic and neutral reproduction. Layer upon layer of steam bent wood are adhered together for uniform structural thickness and optimum rigidity. The combination of uniform thickness and strong geometric shapes results in an anechoic and incredibly strong cabinet.

GENERATION OF WIDEBAND SUPER DRIVERS

In the quest for extended bandwidth and homogenous excellence, Titan series breaks with convention. Fewer devices with higher bandwidth have better harmonic characteristics. Thus the use of one super tweeter and one super midrange is genetically better than the use of a midrange, a tweeter and a super tweeter. Traditionally non uniformities have been tried, solved by way of refinement. Here they are removed from the design at inception, resulting in a detailed and completely compression free sound - so unhindered and shackle-free that sound exits the speaker almost as if it was lightning.

LUXURIOUS PIANO SURFACE

Tigris and Telesto's exterior surface is made of deep luxurious black glossy piano lacquer. The finish is a unique process requiring several stages. The cabinet surface is primed and sanded before multiple layers of black lacquer are applied. The cabinet is then finished with a smooth and deep clear coat that is masterfully polished. The elegant finish complements the iconic design and sculpturally adds sophistication and exclusivity to any home.

**"THIS SPEAKER CERTAINLY
NEEDS TO MAKE NO
APOLOGIES WHEN IT
COMES TO FIT AND FINISH,
COMPENENT QUALITY AND
DESIGN."**

Chris Groppi
Secrets of Home Theater and
High Fidelity

CORE EARTHQUAKE TECHNOLOGIES
FEATURED IN THIS PRODUCT



TITAN THEIA



INTRODUCING THE TITAN THEIA

Titan Theia is the center speaker of the Titan line, designed to perfectly complement the Telesto and Tigris floor standing speakers. It is also ideally suited as an upgrade in other high quality systems needing a true full range center speaker. Theia is capable of thundering dynamics and deep lows all while remaining perfectly composed, detailed and harmonic.

SLAPS - SYMMETRICALLY LOADED AUDIO PASSIVE SYSTEM

As the name indicates, the SLAPS are built symmetrically which distinguishes it from traditional passive devices. SLAPS integrates identical components in its suspension and design ensuring the unit is moving identically in both directions. The revolutionary efficiency and performance are the result of the pneumatic coupling between SLAPS and the active driver. SLAPS overcomes the limitations known from conventional closed and ported designs that prevent radical excursion and deep response. The unique design allows the active driver compression-free movement resulting in deep, dynamic and hard-hitting bass.

In the Theia the quad 4" XLT wideband Kevlar cone woofers are pneumatically coupled to a bottom mounted 10" SLAPS capable of 2" peak-to-peak travel, enabling battlefield level effects to be reproduced effortlessly.

THE THEIA IS THE CENTER SPEAKER OF THE TITAN LINE DESIGNED TO COMPLIMENT THE TELESTO AND TIGRIS

- 4" XLT WIDEBAND KEVLAR CONE WOOFERS
- 10" SLAPS CAPABLE OF 2" PEAK-TO-PEAK TRAVEL

CORE EARTHQUAKE TECHNOLOGIES
FEATURED IN THIS PRODUCT



TITAN HESTIA



INTRODUCING THE TITAN HESTIA

Titan Hestia is a high-end multi-purpose LCR on-wall speaker. The Hestia is ideally suited for anyone desiring a superior audio experience without large floor speakers occupying the room. Its sculptural appearance and low profile on-wall design integrates superbly with flat-screen TVs. Designed to perfectly complement the Telesto and Tigris floor standing speakers it can be used as center and rear speakers in a complete Titan system. It is also ideally suited as an upgrade in other high quality systems needing a competent speaker to fulfill any position in an HT setup. The Hestia is capable of thundering dynamics while remaining perfectly composed, detailed and harmonic.

PERFORMANCE MATTERS

Very few on-wall speakers live up to the acoustic performance of large floor standing stereo speakers. The Hestia ups the ante on performance by incorporating a magnitude of advanced core Earthquake technologies.

CORE EARTHQUAKE TECHNOLOGIES
FEATURED IN THIS PRODUCT



VARI-MOUNT

Designed to be mounted on the wall, Hestia features the Vari-Mount installation system that allows the speaker to be mounted horizontally for center channel application or vertically when used as left, right or surround speaker. Vari-Mount is simple, safe, secure, and requires no special tools or hardware.

LUXURIOUS PIANO SURFACE

Titan Hestia's exterior surface is made of deep luxurious black glossy piano lacquer. The elegant finish complements the design and sculpturally adds sophistication as well as exclusivity to any décor.



CINÉNOVA POWERED AMPS



TWO YEARS OF RESEARCH, THREE NEW TECHNOLOGIES

Earthquake Sound proudly presents the latest iteration of the legendary Cinénova line of multi-channel amplifiers. The Cinénova concept has evolved, giving the mighty Cinénova Grande advanced bridging capabilities and a smaller sibling- the **Cinénova 7**.

For years audiophiles have been asking for an amplifier rivaling the Cinénova Grande in audio excellence, but positioned in the 200 Watt class. The Cinénova name represents the pinnacle of amplification regardless of price. Traditionally, listeners assume that a reduction in power and cost will influence the quality of sound. With a constant demand for this amplifier, Earthquake's chief engineer Joseph Sahyoun descended into the Earthquake research laboratories determined to crack the code to the universe and design an amplifier with no compromise in sound quality while still remaining competitively priced.

Since its inception, the Cinénova design concept has been a tempered blend of traditional high-end virtues combined with innovative and novel circuitry design. Produced using in-house proprietary manufacturing techniques this tradition lives on in the new Cinénova 7 with a completely monaural design and enhanced class A/B operation. The result is industry leading efficiency making the Cinénova 7 a true green amplifier.

During the research process for the Cinénova 7, three core technologies were developed to optimize the amplifier and elevate its performance above its class. These new technologies proved so successful that the Cinénova Grande reference design itself was reborn with them.

CORE EARTHQUAKE TECHNOLOGIES
FEATURED IN THIS PRODUCT





THE MARS TECHNOLOGY

Magnetically Actuated Reanimation System is a new type of protection system that enables the use of all the amplifier's power resources without compromising the survivability of the amplifier under catastrophic conditions. Typical protection systems rely on fuses or relays that complicate the signal path thus degrading audio quality. MARS is different as it is not in the signal path, but works by sensing the electro-magnetic signature of the speaker output wire then translating this input into amperes flowing through the wire. Using the principle discovered by Danish Scientist H.C. Oersted, this design has no impact on the sound quality of the amplifier as it is totally separate from the audio circuits.

The internal communication of MARS is handled via optics rather than electrical circuits. This means MARS does not create an electromagnetic field as no current is flowing through wires. The signal path remains free of artifacts that impact and taint the sound in other designs as no amount of light activity can influence an electrical system.

Normally a relatively large safety margin is necessary because of the antiquated nature of traditional protection systems. MARS operates at 500kHz speed making it deadly accurate. This enables the amplifier to utilize the outputs SOA (safe operating area) to the limit. This gives a MARS enabled amplifier 20% more power than an identical non-MARS amplifier.

During testing the MARS technology showed that the output of the amplifier could be short circuited at full power more than a thousand times with no damage to the amplifier. MARS does not use any relayed or other damping-factor reducing mechanical switches that can wear out or fail over time. Instead, a specially designed circuit instantly shuts off the output device.

In the event a short circuit activates the MARS protection system, it continuously re-scans the output every 10 seconds. Normal operation automatically resumes as soon as the short-circuit condition is removed.



CINÉNOVA POWERED AMPS

ADVANCED BRIDGING CAPABILITY

Cinénova Grande is already the most powerful multi-channel amplifier on the market. The new bridging functionality further extends Cinénova Grande into the wattage stratosphere by breaking the vaunted 1,000 watts at 8 Ohm hifi amplifier barrier. A feat previously accomplished by only a handful of exotic 2 channel high-end amplifiers.

BUILT-IN ELECTRONIC CROSSOVER

This is a unique feature that allows each channel to be adjusted only to reproduce the user's desired frequency range. The crossover function is a superb tool when bi-amping or using a channel as a dedicated subwoofer amplifier.



THE ION TECHNOLOGY

In-Circuit Optimization Network is an advanced network of connection points on the Cinénova circuit-boards. Traditionally, transistors and capacitors are paired, grouped and tested to ensure compatibility.

However, it has been shown especially by exotic and esoteric audiophiles across the globe that even highly refined mass produced amplifiers have substantial room for improvement when individually tweaked and optimized.

A lot happens when individual components are put together in a circuit. A certain margin of difference between two seemingly identical circuits exists. Some engineers refer to this as the "ghost in the machine".

The option of being able to fine-tune and optimize a circuit even after it has been built would be the evolutionary solution- enter the ION technology. ION enables individual tweaking while remaining in a mass production environment.

When the circuit is completed, the ION network is connected to a specially designed diagnostics computer that automatically determines the optimal connections and ION then makes those connections permanent.

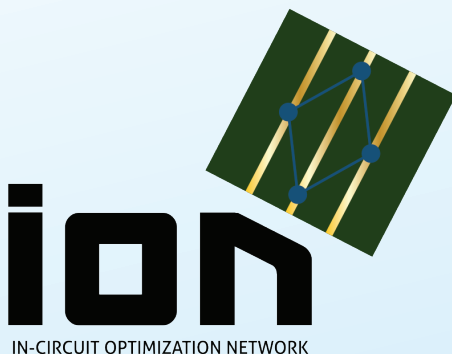

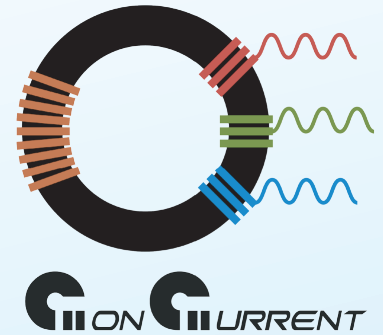

POWER OUTPUT

CINÉNOVA GRANDE
 328W at 8 OHM
 610W at 4 OHM

CINÉNOVA 7
 175W at 8 OHM
 250 at 4 OHM

CONCURRENT POWER SUPPLY

The ConCurrent power supply design ensures full power can be delivered at all times to all channels simultaneously. Earthquake engineers developed the parallel symmetric transformer with identical electromagnetic coupling for each secondary winding. Every channel has its own secondary winding, capacitor bank, rectifiers and output circuitry all mounted on massive, individually, vertically-ripped extruded aluminum heat-sinks. The individual channels remain sovereign and autonomous as sharing is not required. This guarantees that no matter how hard one channel is driven, it will have no effect on surrounding channels.

Power supply efficiency, stiffness, and strength are dependent on several factors, The ConCurrent design is the culmination of intense optimization of all known parameters. To stiffen the supply (lower regulation factor) the transformer cores are made of ferrite instead of a lower grade iron material. The windings are made with the same oxygen free copper that is used in high-end speaker cables. To ensure hum-free operation, the transformer is hard-wound and made with military grade high temperature lacquer.

A high-end design using completely separate output blocks are largely unheard of in this class of amplifier, but with Earthquake's enduring strive for quality and excellence there simply was no other way. From the loudest crescendo to the finest syllable, the Cinénova will remain composed and in control. We invite you to enjoy the unique ownership experience of this Cinénova amplifier that was designed by a brilliant mind and built with loving hands.

SUPERNOVA

MKVI/MKVII



IN A CLASS ALL ITS OWN

The Supernova MKVI/MKVII Series epitomizes the state-of-the-art in subwoofer design. The MKVI/MKVII series is uncompromised in performance and superior technology, coupled with the world's most refined low frequency response. The MKVI/MKVII defines a new standard in a class of its own. The selection of subwoofers is vast, but the top Supernova MKVI/MKVII reign in solitude.

CONTINUING THE LEGACY

With more patented technologies and test awards than any other subwoofer, the MKVI/VII continues the legacy of the legendary MKV series. Patented technologies such as a class J amplifier, SLAPS, overdrive, and ODL as well as proprietary high excursion drivers define MKVI/MKVII's groundbreaking performance.

SLAPS - PATENTED SUPERIORITY

SLAPS is a patented system that dramatically increases subwoofer efficiency and capability for ultra low frequency reproduction. SLAPS (Symmetrically Loaded Audio Passive System) is built symmetrically which distinguishes it from traditional passive devices. SLAPS integrates identical components in its suspension and design ensuring the unit is moving identically in both directions. The unique design allows the active driver compression-free movement resulting in deep, dynamic and hard-hitting bass response.

If you dream of uncompromising LFE performance with superb dynamics and effectiveness combined with quick and precise articulation, the MKVI/MKVII is the obvious choice. The MKVI/MKVII can effortlessly produce the lower octaves in a high-end stereo setup or can add explosive LFE effects in large surround systems.

Manufacturer	Model	Driver	dB at 40Hz	dB at 35Hz	dB at 30Hz	dB at 25Hz	dB at 20Hz	dB at 18Hz
EARTHQUAKE	SUPERNOVA	15"	117	117	116	115	102	98
EARTHQUAKE	SUPERNOVA	12"	115	114	113	106	98	96
B&W	4000-ASW	15"	115	115	115	114	102	N/A
Bag End	S-18E	18"	110	112	110	108	100	N/A
Triad	Platinum	18"	N/A	110	N/A	106	92	90
Velodyne	F-1800R	18"	112	112	113	110	98	N/A
Energy	ES-18XL	18"	112	112	112	106	98	90
Paradigm	Servo-15	15"	110	110	110	106	96	90
Bag End	Infra_18	18"	108	108	106	102	90	N/A

dB Measurements as tested by WIDESCREEN REVIEW with Supernova MKV



EFFORTLESS POWER

MKVI/MKVII's power is generated from the newly developed IQ-600 class J amplifier. The patented class J technology manifests a quantum leap in amplifier technology. The revolutionary aspect of class J is its ability to combine a high efficiency of 99% with extraordinary bass control. Class J is an evolution on PWM technology that combines advanced multi-level feedback with an intelligent controller. It modulates the supply voltage and output switching frequency in real time based on the frequency and amplitude content of the input signal. This added level of intelligence to the amplifier offers several obvious advantages such as increased thermal headroom through the amplifier's optimum energy use, dramatically improved bass response, and dynamic power capabilities. This results in a harder audible impact that adds a drive to the sound normally experienced only at live concerts. This combined with superb articulation, nuances and detail are reproduced by the MKVI/MKVII, but overlooked by traditional subwoofers.



OVERDRIVE - OPTIMAL USE OF ALL POWER RESERVES

Overdrive is a patented system that gives the amplifier exceptional high dynamic output. Overdrive's patented design ensures distortion-free amplification. Overdrive provides a peak power double the IQ-600's nominal specification, making the amplifier capable of reproducing 1200 watt program material.

*The MKVII is also available in a sealed cabinet front firing version for build in applications.

ODL - INTELLIGENT PROTECTION

The patented Optical Distortion Limiting circuit is a revolutionary design that provides full protection against overdriving and distortion. If ODL detects an overdriven signal that cannot be amplified nominally or by overdrive, ODL ensures distortion-free amplification by adjusting the input power in real time.



CORE EARTHQUAKE TECHNOLOGIES
FEATURED IN THIS PRODUCT

CLASS J



SUPERNOVA MKV

SUBWOOFERS



The Supernova MKV is an ultra-powerful subwoofer for the discerning user who wants the best in low frequency reproduction and a straightforward no nonsense user interface. With output capability rivaling that of the MKVI/MKVII and the simplicity of a MiniMe, the MKV is the perfect subwoofer when integrated DSP is not needed or wanted.

Many high-end surround processors have extensive DSP built-in and an increasing number of audiophiles are finding themselves paying twice for this feature. It has become almost impossible to find a high end subwoofer without DSP - enter the Supernova MKV.

UNLIMITED POWER SURPLUS

MKV's brute force springs from the powerful BA212V amplifier capable of producing 1000 Watts MAX power and 600 Watts true RMS power. Built using the robust Earthquake enhanced class D output technology, this amp guarantees effortless power and control. It features high level inputs and outputs, low level RCA inputs and outputs, and a 24dB variable crossover.

CORE EARTHQUAKE TECHNOLOGIES
FEATURED IN THIS PRODUCT



SLAPS - PATENTED SUPERIORITY

SLAPS, Symmetrically Loaded Audio Passive System, is a patented system that dramatically increases subwoofer efficiency and capability for ultra-low frequency reproduction.

The revolutionary efficiency and performance are the results of the pneumatic coupling between SLAPS and the active driver. SLAPS overcomes the limitations known from conventional closed and ported designs that prevent radical excursion and deep response.

The unique design allows the active driver compression-free movement resulting in deep dynamic and hard-hitting bass response

SUPERNOVA MKIV SUBWOOFERS



ENHANCED POWER

The amplifier is based on tried and true Class A/B output technology. Earthquake engineers over the years have developed many circuitry innovations that when combined leads to an enhanced operational state, increasing efficiency and survivability.

SLAPS - PATENTED SUPERIORITY

The patented Earthquake technology dramatically increases sub-harmonic frequency response and dynamic output capability. SLAPS overcomes the limitations known from conventional closed and ported designs that prevent radical excursion and deep response. The powerful XLT active woofer is pneumatically coupled to the passive SLAPS device, both capable of 2 inch peak to peak travel - enabling battlefield level effects to be reproduced effortlessly.

XLT - EXTRA LONG THROW

A woofer geometry originally developed by Earthquake for heavy duty industrial subwoofers to expand excursion potential over regular long-throw woofers. The XLT motor structure allows extreme movement without reduced electromotive coupling. The result is superior transient response and dynamics.

RAW POWER

The Supernova MKIV Series is our most raw, unadulterated performance implementation of the SLAPS technology, and the Supernova name plate itself. Built with the singular obsession to take the bone crushing power of SLAPS, XLT woofer geometry and 450 Watts of enhanced Class A/B wattage to the realm of affordability.

Throwing etiquette and moderation completely out of the window, we have shamelessly shoehorned the proverbial BigBlock V8 into a subcompact, accepting full well that some people will find this much bass at this price point down right offensive. Enjoy harder hitting music beats, and thundering movie effects from a completely gimmick free subwoofer. No blinking displays, useless remote controls, gift bags, or plastic novelty microphones! Welcome to performance.

CORE EARTHQUAKE TECHNOLOGIES
FEATURED IN THIS PRODUCT



MINIME V2 SUBWOOFERS



COMPACT DESIGN, MAXIMUM POWER

The MiniMe V2 is designed to deliver phenomenal bass from a tiny cube and look fantastic while doing so. Earthquake's MiniMe V2 can easily output the right amount of bass for any home from small condos to theater rooms. Always desired in a subwoofer is a small, unobtrusive enclosure that does not compromise quality. MiniMe's flawless design achieves just that.

EXCESS POWER

MiniMe V2 is equipped with an oversized class D amplifier. The advanced class D technology has an efficiency of 90% which means that the amplifier does not get hot even with hard and continuous operation. Earthquake's unique evolved class D design is distinguished by high performance and superb bass control.

SLAPS - PATENTED SUPERIORITY

Like the Supernova subwoofers, MiniMe V2 employs the patented SLAPS passive radiator technology. The revolutionary efficiency and performance are the result of the pneumatic coupling between SLAPS and the active driver. SLAPS overcomes the limitations known from conventional closed and ported designs that prevent radical excursion and deep response. This allows these small subwoofers to produce an unusually powerful bass.

LUXURY FINISHES

The MiniMe V2 is covered in deep luxurious black piano lacquer. The cabinet finish begins with a thorough sanding and priming followed by multiple applications of black lacquer with additional fine sanding between layers. The cabinet is then finished with a smooth, high gloss clear coat.



**MINIME P10 V2 / P12 V2 COME WITH A
REMOTE CONTROL & REMOTE EYE**



CORE EARTHQUAKE TECHNOLOGIES
FEATURED IN THIS PRODUCT



MINIME-P63

SUBWOOFERS



COMPACT AND POWERFUL

The MiniMe P63 was designed for people who love to experience music and movies at full throttle but are tight on space. The MiniMe P63 stands strong through the symbiotic relationship of the one 6.5" premium long throw active driver and two 6.5" passive radiators. The utilization of the passive radiators increases the capability and efficiency for ultra-low frequency reproduction, allowing you to achieve a louder, more powerful bass without requiring more power from the amp.

LIMITED EDITION COLORS

The MiniMe P63 is compact, powerful, and beautiful. Its components are enclosed in a laborious, high-end, piano gloss finish. Available in black and white as well as three limited edition color finishes (red, silver, and yellow), the MiniMe-P63 can easily blend into any décor.

USB COMPATIBLE

Keeping the issue of limited space in mind, the MiniMe P63 offers a conveniently placed 5.2V USB power adapter, allowing the subwoofer to charge or power any other USB compatible devices, to help you economize and utilize your living space more efficiently.



FF SERIES SUBWOOFERS



AN EVOLUTIONARY STEP

The new FF line of subwoofers is the next evolutionary step in the continued quest for superb bass performance. The FF series offers versatility, a small footprint and good looks all while staying surprisingly affordable.

The powerful woofers used in the FF line have direct lineage to the loaded MiniMe subwoofers sporting massive excursion and high power handling. The amplifiers are refined descendants of the signature Sub-Series from Earthquake.

The third generation Earthquake FEA computer-modeled bass Slot-Port loading increases the output of the powerful woofer/amp combo. The new Slot-Port provides more port volume than possible with traditional tubular port loading resulting in radically increased low frequency output. Since it is not a tubular device, it can bend at optimum angles reducing cabinet size making the subwoofer both powerful and aesthetic. It also routes laminar airflow across the aerodynamically shaped internal amplifier heat exchangers.

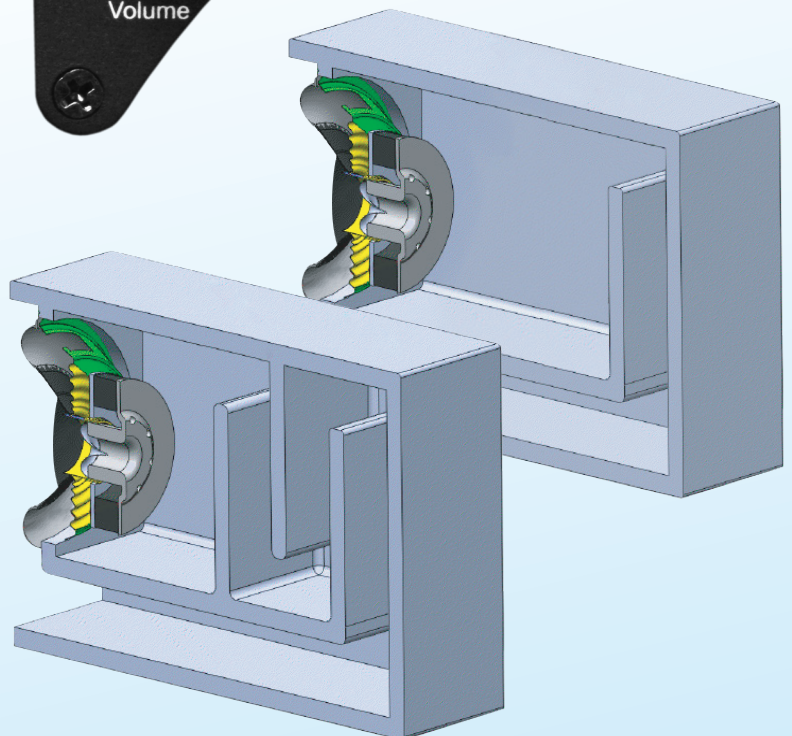

FF-6.5

COUCH POTATO

CP-8



POWERFUL INVISIBLE BASS

The CP-8 is a two time award winning self-powered subwoofer that delivers massive fast bass to your seating position. By placing the subwoofer close to you, the bass is direct, more powerful, and carries massive sub harmonic vibrations with it.

ONLY 7 INCHES TALL

Through an integral high power 300 Watts max amplifier, the Couch Potato subwoofer provides an RCA and high level input and a high level output. The CP-8's high output level is designed to match typical satellite speaker systems to enhance the overall sound quality and performance of your system. Its slim enclosure design allows you to place the CP-8 under the sofa, behind it, or under the bed. By standing it on its side, it further expands your placement options. Now you can have massive bass while incorporating unused space.

SUB-80X

HARD HITTING BASS, STRONG PRICE

This high-powered down-firing subwoofer can handle a large amount of amplifier power despite its small size. The SUB-80X is perfect for smaller homes, condos, and apartments while remaining budget friendly. It fills very large rooms with musical bass and thundering sound effects.

DETAILED ENGINEERING

SUB-80X's optimized flared bass port and down firing construction enhances the acoustic output from the subwoofer. The 2 inch high temperature voice coil and super wide edge surround ensures durability.

The versatile set-up options and attractive wood finish offer broad compatibility with other speakers and allows it to blend into any system in any location.



AR-300

WiFi AUDIO MODULE

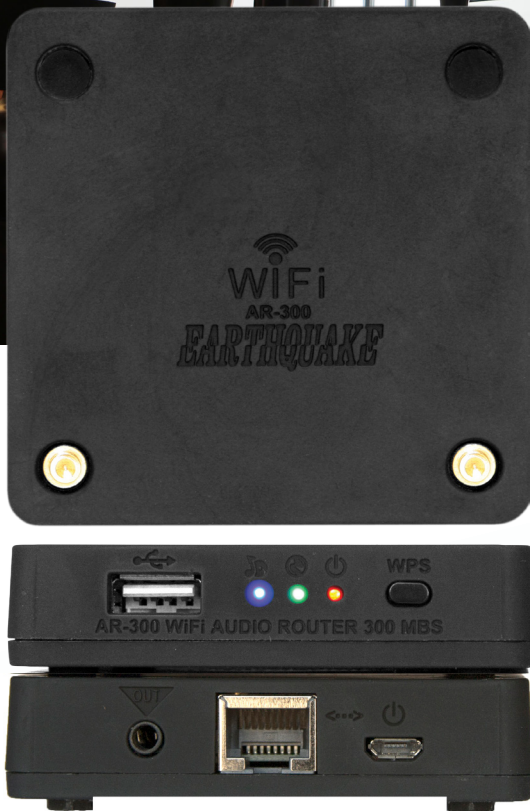

FASTEST ON THE MARKET

Earthquake Sound is proud to introduce its first WiFi high quality audio module: AR-300. With a data rate of up to 300Mbps the AR-300 is easily one of the fastest streaming 2.4GHz WiFi router modules on the market.

CONTROL AT YOUR FINGER TIPS

The AR-300 is designed to work with the free downloadable mobile app, "Earthquake Player" and other open source apps available for Apple®, Android®, and Windows 7-10® devices. The Earthquake Player app allows the module to stream music from your WiFi enabled device(s) at a high quality 128kbps or super high quality 320kbps. A single WiFi enabled device can stream 10 different songs to 10 different zones at the same time.

EXPAND YOUR RANGE

The AR-300 also doubles as a WiFi hotspot, expanding the range of the WiFi network that it is connected to. When installing several modules on the same WiFi network the AR-300 become a mesh metric network with massive speed that allows up to 32 zones of high quality audio processing.

COMPACT POWER SHARING

One might think that with all these capabilities and high power that the AR-300 would be rather large. However, you may be surprised and happy to find out that it is only 3"x 3" and stands less than an inch tall! Its small discrete size coupled with its magnetically stackable design and the nearly unbelievable, high-end multifaceted performance makes the AR-300 the perfect choice for all!

THOR IN-WALL SUB



A TRUE IN-WALL SUBWOOFER

This in-wall subwoofer establishes a new industry standard for in-wall speaker systems. THOR offers a no compromise built-in solution for the finest home-theater and music systems. You won't believe your ears; the aural performance rivals the best free-standing systems.

PATENTED TECHNOLOGIES

Producing deep, chest-pounding bass in a limited space had always been a challenge until now. With a mere 3 3/4" depth, the THOR in-wall subwoofer has the ability to produce sub-harmonic bass as low as 20Hz with no distortions or resonance. Earthquake engineers achieved that by combining two patented technologies: the SWS shallow woofer system and SLAPS passive radiator.

CUSTOMIZE

Consumers will love the Thor for its stellar visual appeal and the unique cosmetic options it delivers, not to mention its impeccable performance. Thor comes ready with two types of grilles, one being a perforated metal grille that is paintable - the other is a custom cloth grille. The custom cloth grille allows user to incorporate any type and color cloth preferred. Now consumers or installers can actually match the subwoofer to the color of the walls or carpet. No matter what their preference is, it is a win-win situation.



INSTALLATION EASY AS 1-2-3

Installation is literally a three-step process; if done correctly, it can be accomplished in 20 minutes or less:

1. Cut a hole in the sheet rock between the standard 16" center-on-center gap or even a 24" center-on-center gap.
2. Drop it in the hole and secure the sheet-rock stabilizers.
3. Bolt the unit into the joists directly from the front.

CORE EARTHQUAKE TECHNOLOGIES
FEATURED IN THIS PRODUCT



MPOWER STUDIO MONITORS



SERIOUS. ELEGANT. UNDERSTATED.

Building on the legacy of the iQuake series the new MPower series continues the quest to be the best powered monitor speaker on the market today.

With a focus honed on audio quality the MPower features wideband ribbon tweeters and stiff aramid glass fiber woofers - powered by a high-end bi-amplification architecture giving each drive unit a dedicated amplifier. Adhering to a stringent high performance, no nonsense philosophy the MPower features clean lines, smooth rounded corners and seamless magnetically attachable grilles.

The dark graphite finish is elegant without being flashy. No gimmicky displays, blinking lights or novelty features. Just serious performance that leaves you free to produce or enjoy music.

VALUE

Built from the ground up with the fundamental elements that make a product distinctly Earthquake - power, performance, and quality. It is our sincere belief that the combination of price, performance, and quality makes the MPower line the best in this category on the market today.

PROVEN TRACK RECORD

For over 27 years Earthquake has been designing and manufacturing top quality audio equipment.

The MPower is no exception to this ledger of excellence. We are certain that you will enjoy using them for many years.



RBS 52

BOOKSHELF SPEAKER



PRECISION

Earthquake Sound proudly introduces its first Reference Bookshelf Speaker the RBS-52. It is a perfect match for home theater set up or passive studio monitor. For over one year, Earthquake audio engineers have worked very hard on designing the RBS-52 to deliver a studio quality sound reproduction along with great aesthetics. Earthquake Sound uses a reinforced wood cabinet that is finished with rounded edges and matte lacquer paint; for those who do not want any obstruction between them and the speakers, Earthquake provides seamless and self-centering magnetic grilles.



TECHNOLOGY

Earthquake Sound has always understood the importance of sound quality and enjoyment of the users' listening experience; that is why the RBS-52 uses 25mm silk dome tweeters to allow faster response, as well as higher frequency range. The 5.25" mid-bass driver has a low mass rigid carbon fiber cone and a large surround that is glued to the basket using Earthquake's patented PistonMax™ technology to provide you with low harmonic distortion as well as 25% more accurate sound pressure level. Both the mid-bass driver and the tweeter are perfectly managed by an internal passive crossover.

FINE TUNING

The finely finished matte black cabinet is designed and engineered with the same care and attention to details as every component of the RBS-52. To enhance the low frequency out of a small reinforced wood cabinet, Earthquake Sound added dual round ports on the back of the rounded-edge cabinet to precisely tune it to 40Hz.

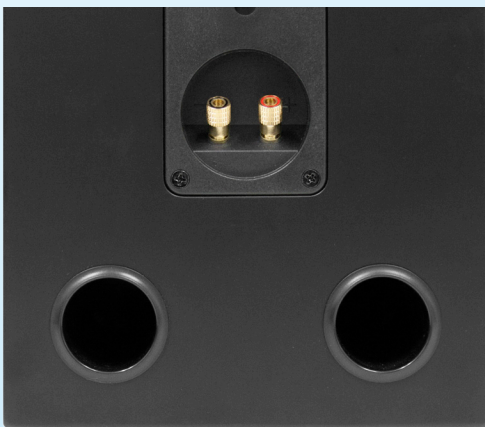

CINÉNOVA IR16

AMPLIFIER

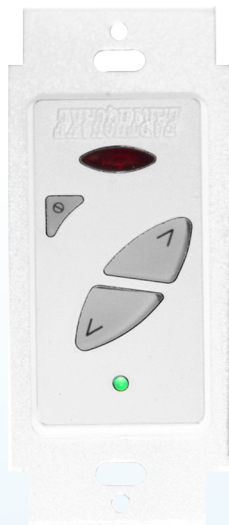

REMOTE READY

The Cinénova IR16 comes complete with 8 individual remote controls, 8 individual keypads, and 4 remote eyes

150 WRMS PER ZONE

This multi zone IR amplifier lives up to the Cinénova name and has become the most powerful multi-zone amplifier on the market. The second generation Cinénova IR16 possesses eight individual power supplies (bilfilar) for power isolation, accuracy, and better channel separation. The Cinénova IR16 can deliver up to 150 Watts RMS per zone, a power rating that is almost unheard of for multi-zone amplifiers.

FEATURES

This amplifier's bridgeable output design enables it to accommodate 4-Ohm and 8-Ohm speakers. Moreover, the LOCAL/BUS input audio selector on each of the eight zones allows it to amplify either a single source or up to 8 different inputs/sources. Included with the Cinénova IR16 is eight sets of external gain keypads and remote controls and four remote eyes. This allows the user to control a different volume for each zone. The Cinénova IR16 offers you more power, more options, and more than you will ever expect in a multi-zone amplifier.

XJ-300ST AMPLIFIER



MULTIPLE MOUNTING OPTIONS FOR ULTIMATE CUSTOMIZATION

Adding to this flexibility comes the new patented EQ interlock design - two amplifiers can be clicked together resulting in a 4 channel amplifier using only 1 U of rack space. The XJ-300ST can also be mounted on the wall or inside the cabinet by fastening the short mounting ears to the pre-assigned holes on the side of the amplifier.

The massive power capability of the XJ-300ST is possible due to the advanced nature of the patented Class J output stage. The switching frequency of the output and the amplitude of the power supply is modulated in real time based on the frequency and amplitude content of the input. No other amp can match the efficiency and power of class J.



ENDLESS POSSIBILITIES

The new XJ-300ST amplifier packs more power and flexibility than any other amplifier. No amplification task is beyond its capability. With an unimposing miniature size and almost unreal amounts of cool running power and an added 12V trigger, this advanced class J amplifier is the installers' go to dream.

VERSATILE MOUNTING OPTIONS

There are additional mounting holes on the sides of the amplifier so that short brackets can be attached and one amp or two interlocked amps can be mounted directly to a wall or inside a cabinet.

When two short ears are attached to two interlock amplifiers, they become rack mountable.

TACTILE TRANSDUCERS

Q10B
MQB1



WHAT IS A TACTILE TRANSDUCER?

Tactile Transducers are subwoofers that emit vibration instead of sound. Earthquake's multi award winning shakers are the strongest on the market.

PATENTED DESIGN

Earthquakes shakers have only one moving part enclosed in a cast-aluminum heat sink, are maintenance free, and virtually indestructible. They are designed for superior music reproduction. Their motors are built around a neodymium magnet and a military-grade aluminum voice coil. This results in high strength and tremendous control.

GROWING APPLICATIONS

The applications for these shakers are ever expanding. You can bolt them to a sofa, chair, platform, and even in your car. They can enhance your current subwoofer's effects or simply replace it. Your home theater, music, and gaming experience can all benefit from these powerful tactile transducers. Available in full and miniature size with multiple mounting options for each, the Q10B and MQB1 make an exciting addition to any system.

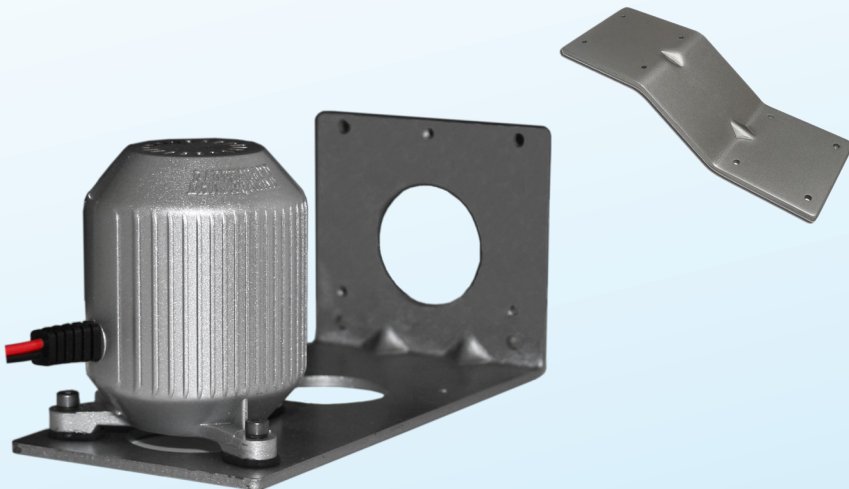

PB-1 MULTIPLIER

This "S" shaped bracket, sold separately, enhances tactile effect for the Q10B.

You can use the PB-1, the included bracket, or directly bolt the transducer to your sofa, chair, or platform. It allows you to have true control of where and how your shakers are set-up.

SHELL SHOXX



INTENSE TACTILE EFFECTS

Shell Shoxx is a system that includes our patented shaker and matching amplifier specifically geared towards the needs and desires of gamers. This hardcore gear will intensify any gaming experience, whether on your computer or gaming console.

300-XX AMPLIFIER

This amplifier draws on the heritage of our legendary XJ-300ST amplifier. It features futuristic class J output technology guaranteeing you unlimited power and cool operation.

MQB-XX SHAKER

The shaker is derived from our MBQ-1 shaker which is a subwoofer that emits vibration instead of sound. MBQ-XX is attached to an arm that can easily clamp onto almost any office chair. Without any mounting assembly necessary, the shaker can be up and running in a matter of minutes.

VIDEO GAMES AND MORE

This gaming set is perfect for all computer and TV video games - especially first person shooters, fighting, car racing, and action adventure games. Plus, Shell Shoxx works with any system so when the video game is turned off Shell Shoxx plays from the audio track. It works whether you are watching a movie, TV, or playing a video game. Shell Shoxx's possibilities are endless.

With a sleek camouflage paint job, Shell Shoxx is sure to add a unique dimension to your gaming experience for any age group in any environment, from dormitories and apartments to living rooms and home offices.



SPECIFICATIONS



Titan Telesto



Titan Tigris



Titan Theia



Titan Hestia

Frequency Response	25Hz - 40kHz	25Hz - 40kHz	30Hz - 35kHz	20Hz - 35kHz
Power Handling	100 - 500W RMS	100 - 500W RMS	300W	300W
Impedance	4 Ohm	4 Ohm	8 Ohm	8 Ohm
Sensitivity	94dB +/-3dB	87dB +/-3dB	89dB +/-3dB	89dB +/-3dB
Enclosure Type	5 chamber ported	3 chamber ported	Sealed array	passive tuned
Tweeter	one 1" & one 1-1/4" silk dome	one 1-1/4" silk dome	two 1" silk dome	two 1" silk dome
Midrange	two 4" Kevlar	one 3" silk dome, ball loaded		
Woofer	one 8" side fiberglass cone	two 8" Kevlar		
Weight	68 lbs per speaker (30.8kg)	89 lbs per speaker (40kg)	13.5 lbs (6.12kg)	13.5 lbs (6.1kg)
Finish	piano black	piano black	piano black	piano black
Dimensions H x W x D	50-1/2" x 7-11/16" x 18-5/16" 1280 x 195 x 465mm	51-1/4" x 10-3/4" x 19-1/4" 1302 x 275 x 487mm	7-1/4" x 31-1/2" x 3-3/10" 184.15 x 800.1 x 83.82mm	5.75" x 19.4" x 12.5" 146 x 492.7 x 317.5mm



Cinenova Grande



Cinenova 7



IR16



XJ-300ST

Channel	5/7	7	16/8 zones	2/ + mono bridge
Power Output RMS	328W - all channels 8 Ohm 610W - all channels 4 Ohm	175W - 8Ohm 250W - 4Ohm	100W - 8 Ohm Bridged 150W - 4 Ohm Bridged	2 x 110W - 8 Ohm 1 x 170W 8 Ohm
THD	0.003%	0.003% at 1W	0.01%	0.08%
Damping Factor	1600 at 8 Ohm	1000 at 8 Ohm	>200	>400
SNR	>121dB	>121dB	92dB	>97dB
Frequency Response	20Hz - 50kHz	20Hz - 30kHz	20Hz - 20kHz	20Hz - 20kHz
Weight	110 lbs / 122 lbs (50/55kg)	80 lbs (36.28kg)	62 lbs (28.12kg)	3.8 lbs (1.7kg)
Finish	silver or flat black	flat black	flat black	flat black
Dimensions H x W x D	9-1/4" x 18" x 21"	6-7/8" x 17" x 16-1/4"	6-1/2" x 18" x 21"	2" x 8-1/2" x 8"



RBS-52



MPower 6



MPower 8

Frequency Response	30Hz - 20kHz	35Hz - 40kHz	30Hz - 40kHz
Power Handling	50 - 300W	105W	125W
Impedance	8 Ohm	8 Ohm	
Sensitivity	90dB		
Enclosure Type	dual ported	rear ported enclosure	
Tweeter	1" silk dome	1" ribbon tweeter	
Midrange	5.25" low mass rigid carbon fiber	aramid glass fiber	
Weight	7.65 lbs (3.47 kg)		
Finish	matte black	matte black	
Dimensions H x W x D	12-3/4" x 9" x 11-1/8"	12-3/4" x 9" x 11-1/8"	15-1/8" x 10-7/17" x 13-3/16"

SPECIFICATIONS



Supernova
MKVI/VII 12



Supernova
MKVI/VII 15



Supernova
MKVII-12S



Supernova
MKVII-15S



Supernova
MKV-12

Power Handling	1200W peak 600W RMS	1200W peak 600W RMS	1000W peak 600W RMS	1200W peak 600W RMS	1000W peak 600W RMS
Input Impedance	18 kOhm	18 kOhm	18kOhm	18kOhm	18kOhm
Frequency Response	15Hz - 155kHz	14Hz - 120Hz	17Hz - 157Hz	16Hz - 122Hz	18Hz - 145Hz
Enclosure Type	Tuned w/ Passive Radiator		Sealed		Tuned w/ Passive Radiator
Weight	85 lbs	109 lbs	82 lbs	105 lbs	84 lbs
Finish	piano black	piano black	piano black	piano black	piano black
Dimensions	16-1/4" x 15-1/2" x 19-1/2"	17-3/4" x 17" x 21"	16-1/4" x 8-3/7" x 19-1/2"	17-3/4" x 20-3/4" x 22"	16" x 15-3/4" x 13-3/4"



MiniMe P8/P8W V2



MiniMe FF 8 V2



MiniMe P10 V2



MiniMe P12 V2



MiniMe P63

Power Handling	320W peak 160W RMS	320W peak 160W RMS	600W peak 460W RMS	600W peak 460W RMS	500W peak
Input Impedance	8 kOhm	8 kOhm	7 kOhm	7 kOhm	
Frequency Response	28Hz - 175Hz	25Hz - 160Hz	20Hz - 135Hz	18Hz - 115Hz	30Hz - 160Hz
Enclosure Type	sealed with passive radiator	front firing	sealed with passive radiator	sealed with passive radiator	dual passive ported enclosure
Weight	16.5 lbs	19 lbs	30.5 lbs	40.2 lbs	10.75 lbs
Finish	Piano black/white	piano black	piano black	piano black	Piano black, white, yellow, red and silver
Dimensions	10-1/4" x 9-3/4" x 11-3/8"	10-1/4" x 9-3/4" x 10-3/4"	12-1/4" x 11-3/8" x 13-3/8"	14-3/4" x 14-1/8" x 16-3/8"	8-9/16" x 8-1/4" x 8-11/16"



CP8



Sub-80X



FF-6.5



FF-10



FF-12



Thor In-Wall Sub

Power Handling	300W peak 150W RMS	300W peak 150W RMS	300W peak 150W RMS	400W peak 200W RMS	400W peak 200W RMS	300W peak 150W RMS
Input Impedance	20 kOhm	20 kOhm				4 kOhm
Frequency Response	20Hz - 180Hz	20Hz - 180Hz	25Hz - 180Hz	25Hz - 125Hz	25Hz - 150Hz	20Hz - 160Hz
Enclosure Type	ported	front ported down firing	front ported front firing	front ported and front firing	front ported and front firing	sealed with passive radiator
Weight	24.5 lbs (11.11kg)	19 lbs (8.6kg)	16.5 lbs (7.4kg)	26.5 lbs (12kg)	37 lbs (16.7kg)	22.5 lbs (10.2kg)
Finish	black laminate	black laminate	black ash	black ash	black ash	white/paintable
Dimensions	7" x 12" x 24"	13-1/4" x 9-7/8" x 13-3/4"	9-15/16" x 7-11/16" x 14-1/4"	13-9/16" x 11-1/2" x 16-1/8"	19-1/2" x 14" x 16-1/8"	28" x 18-5/8" x 3-3/4"

SPECIFICATIONS



Shell Shoxx 300-XX Amp

Channels	1
RMS Pwer Output	160W - 8 Ohm 320W - 4 Ohm
THD	0.03%
Damping Factor	>400
SNR	>90dB
Frequency Response	28Hz - 175Hz
Weight	5 lbs
Finish	camouflage paint
Dimension H x W x D	9-1/2" x 13-3/16" x 3-1/4"



AR-300

Working Voltage	3.5 - 5.0V DC
Operation Temperature	23 - 104 F (-5 - 40 C)
Frequency Range	2.412 - 2.484
DAC	SNR 96dB
Distance	>50ft (>15m)
Finish	matte black
Dimensions	3/16" x 3-1/16" x 3-1/16"



Q10B



MQB-1



Shell Shoxx MQB-XX

Power Handling	1000W peak 600W RMS	500W RMS	20 - 500W RMS
Impedance	8 Ohm	8 Ohm	8 Ohm
Frequency Response	5Hz - 40Hz	15Hz - 50Hz	15Hz - 50Hz
Weight	6 lbs	3 lbs	3.5 lbs
Finish	cast aluminum casing	cast aluminum casing	cast aluminum casing
Dimensions	3-9/16" x 6-3/16" x 3-9/16"	3-1/2" x 3-1/8" x 3-1/8"	3-1/2" x 2-3/4" x 8-1/2"

EQ TECHNOLOGY



AASD: (Acoustic Array System Design) a technology combining higher acoustic efficiency with controlled dispersion ensuring uniform coverage over a wider area. Building on the lessons learned from large professional line array speaker systems, AASD uses positive interference and physical curvature to create a wide fully saturated sweet-spot, allowing for better HT utilization than traditional center speakers.



XLT: (eXtra Long Throw) A woofer geometry originally developed by Earthquake for heavy duty industrial subwoofers to expand excursion potential over regular long-throw woofers.

XLT and PMT work in great synergy as each technology expands on one of the two parameters for sound generation - Bore and Stroke. Ask any car buff and they will say there is no replacement for displacement.



PMT: (Piston-Max Technology) A patented Earthquake technology that enhance acoustical output while keeping a minimal footprint.

Piston-Max moves the speaker surround to the outer edge of the cone body, resulting in a 20 percent increase of surface area. This translates into more sound and higher efficiency.



Symmetrically Loaded Audio Passive System
The patented Earthquake technology dramatically increases sub-harmonic frequency response and dynamic output capability. As the name indicates, SLAPS is built symmetrically which distinguishes it from traditional passive devices. SLAPS technology is a key player in translating high electrical power into dominating LFE.

The revolutionary aspect of Class J is its ability to combine ultra high efficiency of 99% with extraordinary bass control. The patented Class J output stage ensures stellar audio quality and takes the concept of the "intelligent circuit" a step further by actually adapting the electrical operation of the output stage to the signal it is playing. This can rightly be considered a quantum leap in amplifier technology.

RAVE REVIEWS

SUPERNOVA MK SUBWOOFER [WIDESCREEN REVIEW]

“Supernova is the most powerful home theater subwoofer I’ve ever heard...”

“It beats the other vented designs for fidelity and delivers higher output than any other compact home theater subwoofer I’ve reviewed”

THOR SUB-10 [Widescreen Review Magazine]

It has been said that many Americans are searching for two things: the best cheeseburger on the planet and more bass, I haven’t found the cheeseburger yet (although i have some favorites), and im looking for the bass. Not just more bass, but better bass. Earthquake Sound-not the best name to use in California-manufactures home audio and mobile loudspeakers and audio components and accessories.”

“The company has developed THOR SUB-10 an in-wall subwoofer system to reach the depths of our needs for earth-shaking extended bass response. There is something about visceral, deep, almost inaudible bass that stimulates everyone from highway cruisers to audiophiles. But bass is best evaluated on the basis of quality, not quantity.”

“The THOR system is capable of deep, extended bass response for both music and movie sources. Big bass improvement.”

CINENOVA GRANDE [Home Theater Magazine]

“Once I got the Cinénova Grande on the measuring bench, I was even more astounded - it measured exactly as Earthquake had specified.”

“Earthquake has gone to considerable lengths to prove that a potent combination of speed, grace, and power can be harnessed on a large chassis. The harder I pushed the Cinénova Grande, the less distortion I got.”

There are several very subtle details that only the best amps, preamps, and speakers can uncover. The Cinénova Grande unveiled them all.”

Q10B TACTILE TRANSDUCER [SECRETS OF HOME THEATER AND HIGH FIDELITY]

“That’s right. You could vibrate the entire floor of your home theater with this unit.”

“...it is the most powerful one I have ever experienced. And the amplifier is the most flexible.”

“...it is an accessory worth having. In fact, never to be without again.”

TITAN TELESTO [SECRETS OF HOME THEATER AND HIGH FIDELITY]

“The Telestos definitely have a neutral tonality to them, and this comes across as sounding ‘natural’...”

“The Earthquake Titan Telesto speakers are unusual in that they have to tweeters dividing the high frequencies between them. The result is extra detail and clarity, which makes this product especially worthy of auditioning if you are in the market.”

COUCH POTATO: CP8 [SECRETS OF HOME THEATER AND HIGH FIDELITY]

“When driven hard, it never exhibited strain, though the cone was pumping vigorously. I was impressed! No distracting port noises of huffing were noted”

“The size and shape allow for easy concealment, and the bass output is nothing short of remarkable.”

“The Earthquake Audio CP-8 left me shaken and satisfied while adding some ‘fun’ to my media enjoyment at a modest cost.”

MINIME [HARTFORD COURANT, COURANT.COM]

“It’s capable of reaching sonic peaks of 108 decibels - somewhere between a jackhammer, a chain saw, and midfield at the Super Bowl. This little lug can rumble.”

“The doors were still rattling down into the low 20s. That’s superb output from a subwoofer this small.”

“...it sounded as loud a lot of its much bigger rivals.”



Earthquake Sound Corporation
2727 McCone Avenue Hayward, CA 94545 USA
Tel: (510) 732-1000 | U.S. Toll Free: (800) 576-7944 | Fax: (510) 732-1095
www.earthquakesound.com