



The Sound That Will *Move* You

DJ-ARRAY GEN2 **LINE ARRAY SPEAKER SYSTEM**



OWNER'S MANUAL

TABLE OF CONTENTS

About Earthquake Sound Corporation	3
Introduction	4
Safety Instructions	5
Assembling DJ-Array GEN2	6-7
Connecting DJ-Array GEN2.....	8
Specifications.....	9
1 Year Warranty Guidelines.....	10
For Your Records	11



The Sound That Will *Move* You

Earthquake Sound Corporation
2727 McCone Avenue
Hayward, CA 94545
United States of America
Tel: 510-732-1000
Fax: 510-732-1095



WARNING: This product is capable of generating high sound pressure levels. You should exercise caution when operating these speakers. Long term exposures to high levels of sound pressure will cause permanent damage to your hearing. Sound pressure levels exceeding 85dB can be dangerous with constant exposure, set your audio system to a comfortable loudness level. Earthquake Sound Corporation does not assume liability for damages resulting from the direct use of Earthquake Sound audio product(s) and urges users to play volume at moderate levels.

© 2021 Earthquake Sound Corporation. All rights reserved.

This document should not be construed as a commitment on the part of Earthquake Sound Corporation. The information is subject to change without notice.

Earthquake Sound Corporation assumes no responsibility for errors that may appear within this document.

ABOUT EARTHQUAKE SOUND CORPORATION

For over 30 years, Earthquake Sound has been producing a variety of high quality audio products that have impressed audiophile communities around the world. It all started in 1984 when Joseph Sahyoun, a music freak and Aerospace Engineer unhappy with the existing loud speaker technology and performance, decided to put his advance engineering knowledge to use. He pushed technological boundaries to the limit to create the kind of subwoofer he could live with. Earthquake quickly created a name for itself in the car audio industry and became well known for its powerful subwoofers and amplifiers. In 1997, using his existing expertise in the audio industry, Joseph Sahyoun expanded his company to home audio production.

Earthquake Sound has since evolved into a leader in the home audio industry, producing not only subwoofers and amplifiers but surround speakers and tactile transducers as well. Engineered by audiophiles for audiophiles, Earthquake Sound audio products are meticulously crafted to reproduce each and every single note perfectly, bringing your home theater experience to life. With true dedication and full attention to details, Earthquake Sound engineers continuously develop new and better products to meet customers' needs and go beyond their expectations.

From mobile audio to prosound and home audio, Earthquake Sound has been selected as the winner of many prestigious awards based on sound quality, performance, value and features. CEA and numerous publications have awarded Earthquake Sound with over a dozen design and engineering awards. Additionally, Earthquake Sound has been granted many design patents by the USPO for revolutionary audio designs that have changed the sound of the audio industry.

Headquartered in a 60,000 square foot facility in Hayward, California USA, Earthquake Sound currently exports to over 60 countries worldwide. In 2010, Earthquake Sound expanded its export operations by opening a European warehouse in Denmark. This accomplishment was recognized by the US Department of Commerce who honored Earthquake Sound with an Export Achievement award at the 2011 Consumer Electronic Show. Just recently, the US Department of Commerce presented Earthquake Sound with another Export Achievement award for expanding its export operations in China.

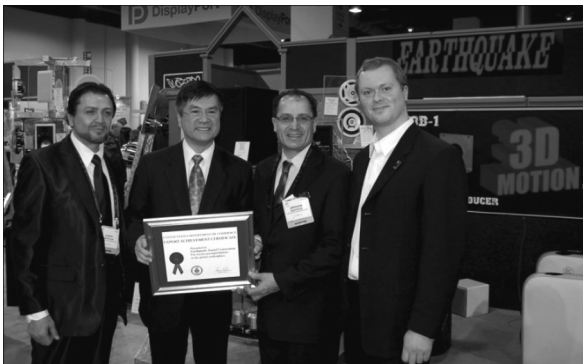

Joseph Sahyoun, US Secretary of Commerce Gary Locke, Abraham Sahyoun and Thomas Mygind



US Commercial Officer Sarah Fox and Joseph Sahyoun



INTRODUCTION

The DJ-Array GEN2 line array speaker system consists of two 4x4-inch array speakers that were designed for DJ and pro sound applications or where sound reinforcement is needed.

The complete DJ-Array GEN2 System consists of the following packaged items:

In The Box

- Box A with a set of 4 x 4" array speaker modules
- Box B with a set of 4 x 4" array speaker modules
- Box A with one metal mounting bracket
- Two 16.5 feet (5m) 1/4" TRS speaker cables
- Mounting Hardware

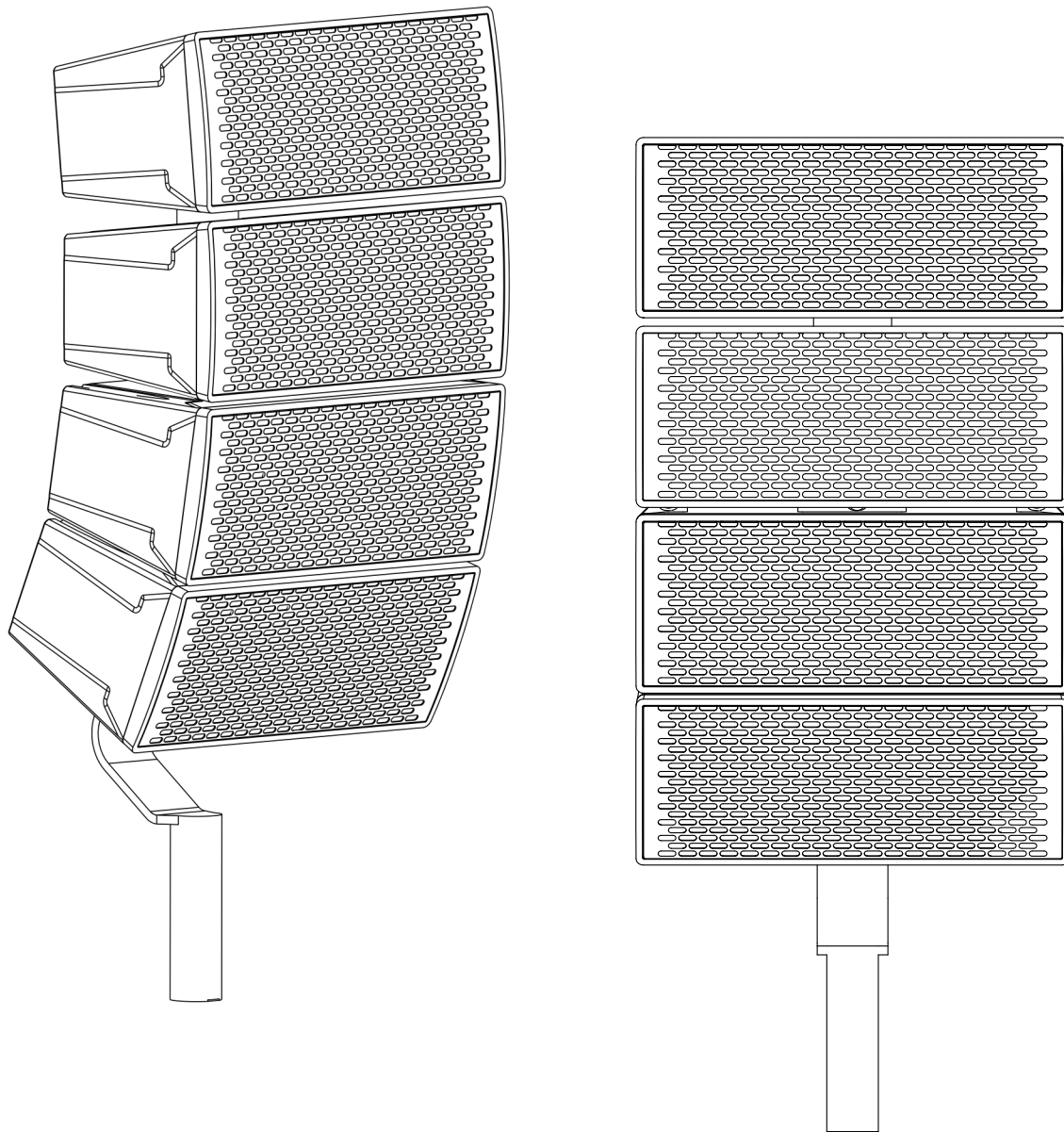

SAFETY INSTRUCTIONS

Safety First

This documentation contains general safety, installation, and operating instruction for the DJ-Array Gen2 speaker system. It is important to read this owner's manual before attempting to use this product. Pay particular attention to the safety instructions.

Symbols Explained:



Appears on the component to indicate the presence of uninsulated, dangerous voltage inside the enclosure - that may be sufficient to constitute a risk of shock.

CAUTION

Calls attention to a procedure, practice, condition or the like that, if not correctly performed or adhered to, could result in injury or death.

WARNING

Calls attention to a procedure, practice, condition or the like that, if not correctly performed or adhered to, could result in damage to or destruction of part or all of the product.

NOTE:

Calls attention to information that is essential to highlight.

Important Safety Instructions:

- 1) Read these instructions in their entirety.
- 2) Store this manual and packaging in a safe place.
- 3) Read all warnings.
- 4) Follow instructions (do not take shortcuts).
- 5) Do not use this apparatus near water.
- 6) Clean only with a dry cloth.
- 7) Do not block any ventilation openings. Install in accordance with the manufacturer's instructions.
- 8) Do not install near any heat sources such as radiators, heat registers, stoves, or other apparatuses that produce heat.

- 9) Do not defeat the safety purpose of the polarized or grounding-type plug. A polarized plug has two blades with one wider than the other. The grounding-type plug has two blades and a third grounding prong. The wide blade or the third prong is provided for your safety. If the provided plug does not fit into your outlet, consult an electrician for replacement of the obsolete outlet.
- 10) Protect the power cord from being walked on or pinched, particularly at plugs, convenience receptacles, and the point where they exit from the apparatus.
- 11) Only use attachments and accessories specified by the manufacturer.
- 12) Use only a compatible rack or cart for the final resting position.
- 13) Unplug this apparatus during lightning storms or when unused for a long period of time.
- 14) Refer all servicing to qualified service personnel. Servicing is required when the apparatus has been damaged in a way such as: power-supply cord or plug is damaged, liquid has been spilled or objects have fallen into the apparatus, the apparatus has been exposed to rain or moisture, does not operate normally, or has been dropped.
- 15) To reduce the risk of fire or electric shock, do not expose this apparatus to rain or moisture.

System Installation Considerations

There are several factors to consider before installing.

What are the intended listening zones?

From where in each zone will the listener prefer to control the system? Where will the subwoofer or amplifier be located?

Where will the source equipment be located?

ASSEMBLING DJ-ARRAY GEN2 SPEAKERS

Before you begin assembling the DJ-Array GEN2 speaker system, make sure that you have all of the required mounting hardware. Each array requires 12 bolts and four nuts for assembly.

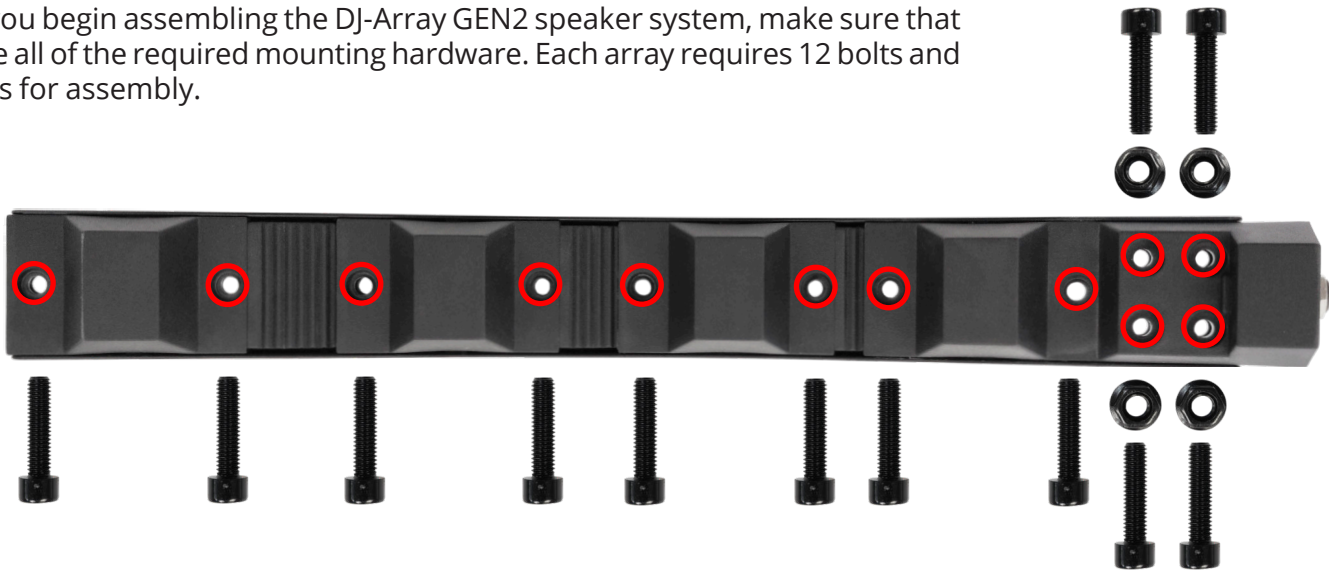

1.

With the included mounting hardware, fasten the 35mm speaker stand bracket to the main speaker mounting bracket with a 3/16 hex key allen wrench (not included). Slide the brackets together as shown in the images to the right and use four of the nuts and bolts to secure them together.

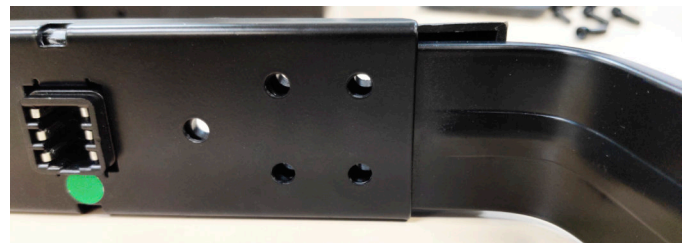
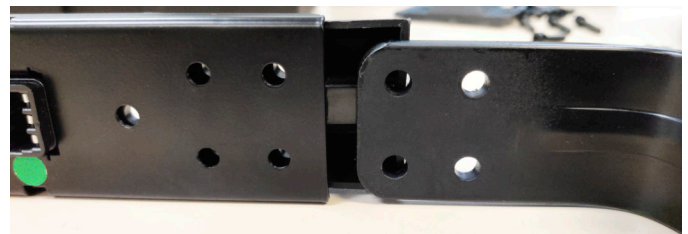

Note

The speaker stand mounting bracket is designed to slide into a channel found at the base of the main speaker mounting bracket shown in the images to the right. Also note that Prior to assembling the DJ-Array system, you will notice that there are four boxes of components in the carton. Two boxes will have the array modules and the other two will have the mounting brackets with hardware. You will need to make sure that the correct modules go with the correct bracket. If the green dot on the array module does not match up with the green dot on the mounting bracket then the array modules will run out of phase.



Match box L with box A
Match box R with box B



ASSEMBLING DJ-ARRAY GEN2 SPEAKERS CONT.

2.

With the mounting brackets assembled, begin mounting the array speakers with the remaining mounting hardware. Each of the four array speakers will require two bolts to securely fasten them to the mounting bracket. Align the speaker contacts with the mounting bracket contacts and gently push the speaker into place. Secure the array speaker with the two bolts and be careful not to over tighten them. Doing so could strip the threads inside the speaker. Repeat this step for the remaining pieces until all for speakers are securely fastened to the mounting bracket.



3.

The DJ-Array GEN2 line array speaker system is now ready to mount onto a stand. Earthquake Sound supplies speaker stands (sold separately) that can match with the DJ-Array GEN2. The 2B-ST35M steel speaker stand is recommended for this array speaker.



CONNECTING DJ-ARRAY GEN2 SPEAKERS

The DJ-Array GEN2 speakers are equipped with 1/4" TRS input connectors at the bottom portion of the mounting bracket. With the supplied TRS cables, gently push one end of the TRS cable plug into the input as shown below and push the other end into

your amplifier or powered subwoofer. The DJ-Quake Sub v2 is a great choice to pair with these array speakers as it features multiple inputs and outputs as well as an active 12 inch subwoofer to create the ultimate and portable DJ system.

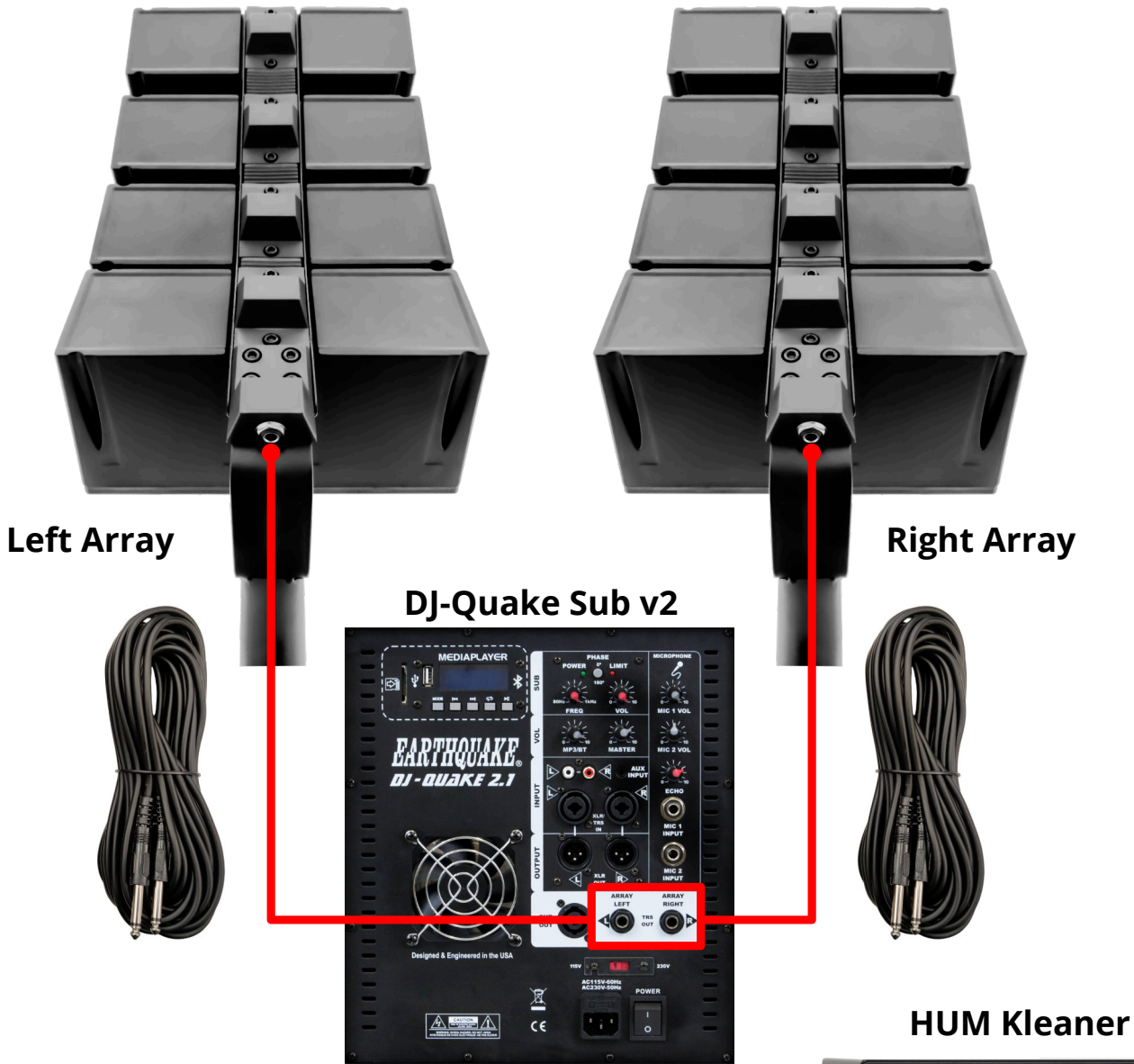

Using the supplied 1/4" TRS cables, connect left and right DJ-Array GEN2 speaker systems to the left and right array inputs located on the back of the DJ-Quake Sub v2 or any other amplifier that supports 1/4" TRS inputs. You do not need to run any other speaker cables for these array speakers due to the convenient internal wiring inside the mounting bracket.

Earthquake strongly recommends using the HUM Kleaner active line converter and pre-amplifier when your audio system is susceptible to noise at the source or when you need to push an audio signal through long wire runs. Please refer to the manual before setting up and using this product.

SPECIFICATIONS

DJ-ARRAY GEN2	
Power Handling RMS	50 Watts Per Channel
Power Handling MAX	100 Watts Per Channel
Impedance	4-Ohm
Sensitivity	98dB (1w/1m)
High Pass Filter	12dB/oct @ 120Hz–20kHz
Array Components	4" Midrange 1" Compression Driver
Input Connectors	1/4" TRS
Net Weight (1 Array)	20 lbs (18.2 kgs)

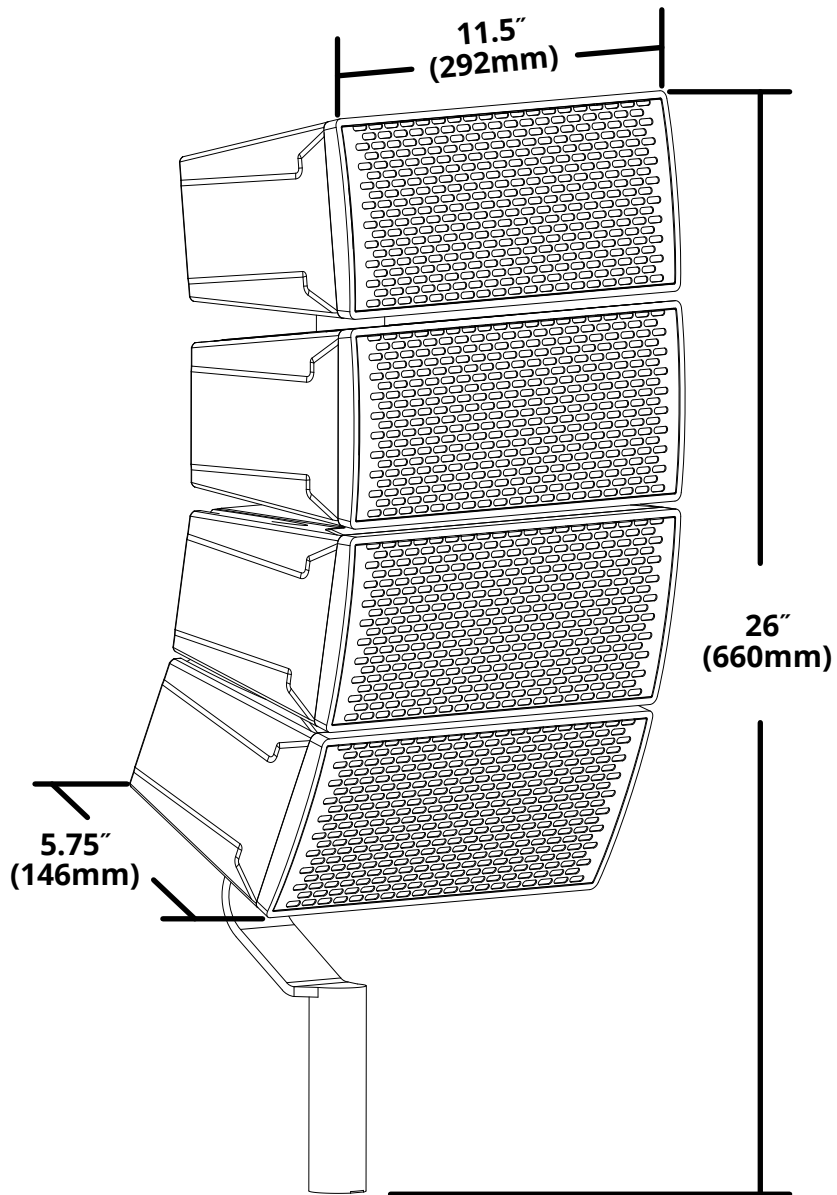

ONE (1) YEAR LIMITED WARRANTY GUIDELINES

Earthquake warrants the original purchaser that all Factory Sealed New Audio Products to be free from defects in material and workmanship under normal and proper use for a period of one (1) years from the date of purchase (as shown on the original sales receipt with serial number affixed/written on it).

The one (1) year warranty period is valid only if an authorized Earthquake dealer properly installs the product and the warranty registration card is properly filled out and sent to Earthquake Sound Corporation.

(A) One (1) year limited warranty plan coverage guidelines:

Earthquake pays for labor, parts, and ground freight (only in US mainland, not including Alaska and Hawaii. Shipping to us is not covered).

(B) Warning:

Products (sent for repair) that are tested by Earthquake technicians and deemed to have no problem(s) will not be covered by the one (1) year limited warranty. Customer will be charged a minimum of one (1) hour of labor (at the ongoing rates) plus shipping charges back to customer.

(C) Earthquake will repair or replace at our option all defective products/parts subject to the following provisions:

- Defective products/parts have not been altered or repaired by other than an Earthquake factory-approved technicians.
- Products/parts are not subjected to negligence, misuse, improper use or accident, damaged by improper line voltage, used with incompatible products or have its serial number or any part of it altered, defaced or removed, or have been used in any way that is contrary to Earthquake's written instructions.

(D) Warranty Limitations:

Warranty does not cover products that have been modified or abused, including but not limited to the following:

- Damages to speaker cabinet and cabinet finish due to misuse, abuse or improper use of cleaning materials/methods.
- Bent speaker frame, broken speaker connectors, holes in speaker cone, surround & dust cap, burnt speaker voice coil.
- Fading and/or deterioration of speaker components & finish due to improper exposure to elements.
- Bent amplifier casing, damaged finish on the casing due to abuse, misuse or improper use of cleaning material.
- Burnt tracers on PCB.
- Product/part damaged due to poor packaging or abusive shipping conditions.
- Subsequent damage to other products.

A warranty claim will not be valid if the warranty registration card is not properly filled & returned to Earthquake with a copy of the sales receipt.

(E) Service Request:

To receive product service, contact Earthquake Service Department at (510) 732-1000 and request an RMA number (Return Material Authorization). Items shipped without a valid RMA number will be refused. Make sure you provide us with your complete/correct shipping address, a valid phone number, and a brief description of the problem you are experiencing with the product. In most cases, our technicians might be able to resolve the problem over the phone; Thus, eliminating the need to ship the product.

(F) Shipping Instructions:

Product(s) must be packaged in its original protective box(es) to minimize transport damage and prevent repackaging cost (at the ongoing rates). Shipper claims regarding items damaged in transit must be presented to carrier. Earthquake Sound Corporation reserves the right to refuse improperly packed product.

FOR YOUR RECORDS

Model Name/Number: _____

Serial Number: _____

Date of Purchase: _____

Authorized Dealer/Installer Info:

Name: _____

Address: _____

Phone: _____

Notes



The Sound That Will *Move* You

Earthquake Sound Corporation

2727 McCone Avenue. Hayward CA, 94545. USA

US Toll Free: 800-576-7944 | Phone: 510-732-1000 | Fax: 510-732-1095

www.earthquakesound.com | www.earthquakesoundshop.com