



The Sound That Will Move You

SuperNova
Luminous

LU-12 & LU-15

*“There might be better subwoofers on the planet,
but I haven’t heard them.”*



Owner's Manual

Table of Contents

About Earthquake Sound.....	3
Safety Instructions.....	4
Unpacking Tips.....	5
Introduction.....	6
What Makes a Supernova Luminous?.....	6
LM1000 Amplifier Overview.....	7
Placing Your Subwoofer(s).....	8
Connecting Your Subwoofer(s).....	9
Tuning Your Subwoofer(s).....	10
Dimensions and Specifications.....	11
Warranty Information.....	12
For Your Records.....	13
Notes.....	14



The Sound That Will *Move* You

Earthquake Sound Corporation
2727 McCone Avenue
Hayward, CA 94545 USA
Tel: 510-732-1000
Fax: 510-732-1095



WARNING: This product is capable of generating high sound pressure levels. You should exercise caution when operating these speakers. Long term exposures to high levels of sound pressure will cause permanent damage to your hearing. Sound pressure levels exceeding 85dB can be dangerous with constant exposure. Set your audio system to a comfortable loudness level. Earthquake Sound Corp. does not assume liability for damages resulting from the direct use of Earthquake Sound audio product(s) and urges users to play volume at moderate levels.

© 2020 Earthquake Sound Corporation. All rights reserved.

This document should not be construed as a commitment on the part of Earthquake Sound Corporation.

The information is subject to change without notice.

Earthquake Sound Corporation assumes no responsibility for errors that may appear within this document.

About Earthquake Sound Corporation

For over 30 years, Earthquake Sound has been producing a variety of high quality audio products that have impressed audiophile communities around the world. It all started in 1984 when Joseph Sahyoun, a music freak and Aerospace Engineer unhappy with the existing loud speaker technology and performance, decided to put his advance engineering knowledge to use. He pushed technological boundaries to the limit to create the kind of subwoofer he could live with. Earthquake quickly created a name for itself in the car audio industry and became well known for its powerful subwoofers and amplifiers. In 1997, using his existing expertise in the audio industry, Joseph Sahyoun expanded his company to home audio production.

Earthquake Sound has since evolved into a leader in the home audio industry, producing not only subwoofers and amplifiers but surround speakers and tactile transducers as well. Engineered by audiophiles for audiophiles, Earthquake Sound audio products are meticulously crafted to reproduce each and every single note perfectly, bringing your home theater experience to life. With true dedication and full attention to details, Earthquake Sound engineers continuously develop new and better products to meet customers' needs and go beyond their expectations.

From mobile audio to prosound and home audio, Earthquake Sound has been selected as the winner of many prestigious awards based on sound quality, performance, value and features. CEA and numerous publications have awarded Earthquake Sound with over a dozen design and engineering awards. Additionally, Earthquake Sound has been granted many design patents by the USPTO for revolutionary audio designs that have changed the sound of the audio industry.

Headquartered in a 60,000 square foot facility in Hayward, California USA, Earthquake Sound currently exports to over 60 countries worldwide. In 2010, Earthquake Sound expanded its export operations by opening a European warehouse in Denmark. This accomplishment was recognized by the US Department of Commerce who honored Earthquake Sound with an Export Achievement award at the 2011 Consumer Electronic Show. Just recently, the US Department of Commerce presented Earthquake Sound with another Export Achievement award for expanding its export operations in China.



Joseph Sahyoun, US Secretary of Commerce Gary Locke, Abraham Sahyoun and Thomas Mygrind



US Commercial Officer Sarah Fox and Joseph Sahyoun



Safety Instructions

Safety First

This document contains general safety, installation, and operating instructions for the LM1000 amplifier. It is important to read this user's manual before attempting to use this product. Pay particular attention to the safety instructions.

Symbols Explained:



Appears on the component to indicate the presence of uninsulated, dangerous voltage inside the enclosure - that may be sufficient to constitute a risk of shock.

CAUTION

Calls attention to a procedure, practice, condition or the like that, if not correctly performed or adhered to, could result in injury or death.

WARNING

Calls attention to a procedure, practice, condition or the like that, if not correctly performed or adhered to, could result in damage to or destruction of part or all of the product.

NOTE:

Calls attention to information that is essential to highlight.

Important Safety Instructions:

- 1) Read these instructions in their entirety.
- 2) Store this manual and packaging in a safe place.
- 3) Read all warnings.
- 4) Follow instructions (do not take shortcuts).
- 5) Do not use this apparatus near water.
- 6) Clean only with a dry cloth.
- 7) Do not block any ventilation openings. Install in accordance with the manufacturer's instructions.
- 8) Do not install near any heat sources such as radiators, heat registers, stoves, or other apparatuses that produce heat.

- 9) Do not defeat the safety purpose of the polarized or grounding-type plug. A polarized plug has two blades with one wider than the other. The grounding-type plug has two blades and a third grounding prong. The wide blade or the third prong is provided for your safety. If the provided plug does not fit into your outlet, consult an electrician for replacement of the obsolete outlet.
- 10) Protect the power cord from being walked on or pinched, particularly at plugs, convenience receptacles, and the point where they exit from the apparatus.
- 11) Only use attachments and accessories specified by the manufacturer.
- 12) Use only a compatible rack or cart for the final resting position.
- 13) Unplug this apparatus during lightning storms or when unused for a long period of time.
- 14) Refer all servicing to qualified service personnel. Servicing is required when the apparatus has been damaged in a way such as: power-supply cord or plug is damaged, liquid has been spilled or objects have fallen into the apparatus, the apparatus has been exposed to rain or moisture, does not operate normally, or has been dropped.
- 15) To reduce the risk of fire or electric shock, do not expose this apparatus to rain or moisture.

System Installation Considerations

There are several factors to consider before installing Earthquake Sound's Supernova Luminous 1000 Amplifier.

What are the intended listening zones?

From where in each zone will the listener prefer to control the system? Where will the subwoofer be located?

Where will the source equipment be located?

Connection Tips

- Keep all power cords away from all signal cables to prevent humming from induced noise.
- Choose reliable signal cable cords (Earthquake Sound also specializes in high performance RCA cables and patches).
- All speaker wires that are ran trough the walls should be twisted type to reduce potential hum noise pick-up.
- It is best to use a grounded electrical outlet to power the amplifier. Lack of input ground reference could be unsafe. Consult with your electrical contractor about proper grounding.

Safe & Proper Handling

The Supernova Luminous subwoofer is considerably heavy for an average person to carry or maneuver. To prevent injuries and eliminate any possible damage to your Supernova Luminous, we encourage you to employ the help of a friend when unpacking the unit. We further suggest the following.

- Always wear a back support belt when carrying/ lifting the subwoofer.
- If possible, get someone to help you move your subwoofer.
- Do not apply pressure or push against the face of the speaker as this will cause irreparable damage to the cone and suspension.
- When carrying your LU-12/LU-15, make sure that the speakers/grilles are away from your chest, eliminating the chance of pushing against the face of the speaker.
- Do not drop the LU-12/LU-15 or subject it to sudden shocks. This will damage the external finish and weaken the enclosure, creating air leaks.
- Avoid exposing the LU-12/LU-15 to moisture. Water will damage the wood structure as well as the amplifier and speaker.
- Cleaning the LU-12/LU15 is best using a soft cloth. If needed, use a mild detergent with water. Like any other electrical unit, always unplug the unit before cleaning it.

Unpacking The LU-12 & LU-15

- Keep the original carton and packing materials for future shipment storage.
- Check for any visual signs of damage. If you encounter any concealed damage, consult your Earthquake Sound dealer before proceeding with unit installation.
- Retain the sales receipt as it establishes the duration of the limited warranty and provides information for insurance purposes.

The Supernova Luminous is packaged well for safety. We highly suggest having a padded surface and at least two (2) people to safely unpack the subwoofer.

Step 1:

On a padded surface, carefully place the box on its side to remove the bottom packing tape and staples.



Step 2:

Without tilting the box too much, tug the bottom flaps outward and keep the protective foam in place.



Step 3:

Gently reposition the box upright.

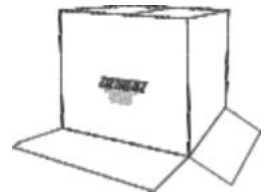

Step 4:

Slide the box off, minding the protective foam on the top, bottom, and sides of the subwoofer.



This triangle, which appears on your component, alerts you to the presence of uninsulated, dangerous voltage inside the enclosure - voltage that may be sufficient to constitute a risk of shock.

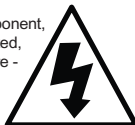

CAUTION
RISK OF ELECTRIC SHOCK
DO NOT OPEN



This triangle, which appears on your component, alerts you to important operating and maintenance instructions in this accompanying literature.



Introduction

Congratulations and thank you for choosing the Earthquake Supernova Luminous subwoofer as a key component of your audiophile system.

The Supernova Luminous subwoofer utilizes the digital Class “D” amplifier circuitry with ODL (Optical Distortion Limiting) circuitry, SLAPS (Symmetrically Loaded Audio Passive System) passive radiator and specially designed high excursion driver. All those components are encased in high quality cabinet specifically designed to reduce internal resonance and diffraction, allowing the Supernova to deliver a crisper bass and more accurate response.

Individually handcrafted in the USA, the Supernova Luminous meets and exceeds all industry standards or performance and quality. With uncompromising “World Class” performance and superior technology, the Supernova Luminous epitomizes the state-of-the-art in subwoofer design.

What Makes A Supernova Luminous?

LM1000 Digital Class “D” Amplifier

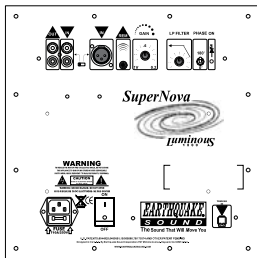

The LM1000 digital custom installation amplifier utilizes the Class “D” circuitry, allowing the amplifier to produce a massive 600 WRMS with 99% efficiency.

Additionally, it also uses ODL (Optical Distortion Limiting) circuitry, a patented process that converts the analog audio signal to a light and optically couple it to the driver stage, preventing the amplifier from clipping when the gain is set too high and therefore, limiting the distortion to near nil levels.

SLAPS (Symmetrically Loaded Audio Passive System)



Earthquake’s own patented SLAPS passive radiator technology dramatically increases the subwoofer’s efficiency and capability for ultra low frequency reproduction. The unique design of the SLAPS employs dual

(identical) suspensions, allowing the passive driver to move the same amount of air in either direction. Coupled with the active driver, the SLAPS enables the woofer to move more than 4” peak-to-peak and adds an excess of 5 dB at 15Hz, more than twice as load at that frequency.

Proprietary High Excursion Drivers



The active driver in the Supernova Luminous is specifically designed for accurate reproduction of bass and sub-bass frequencies. With a massive moving structure, these drivers operate with extremely low distortion and impressive

transient response. Their performance is attributed to a non-conventional motor structure design that integrates components such as a double stacked, high-gauge magnets, epoxy coated super spiders and over 1 inch of single layer, thermally pressed poly-ether foam surrounds.

LM1000 Amplifier Overview

The LM1000 amplifier offers features and technologies that allow it to deliver uncompromising performance, even under extreme conditions. The next few pages will describe in details the LM1000 built-in functions and their applications.

We strongly recommend that you review these pages and feel free to contact us if you have any questions.

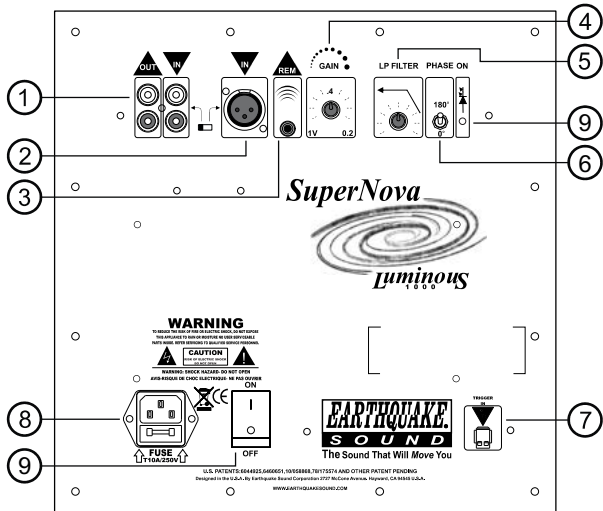

(1) RCA/LOW LEVEL INPUT & OUTPUT

This is the best way to drive audio signal to the LM1000 Supernova MKV amplifier. The low level output is crossed in high pass mode at 100Hz, perfect source to feed a center channel amp.

NOTE: DO NOT USE HIGH LEVEL AND LOW LEVEL INPUTS AT THE SAME TIME.

(2) BALANCED XLR INPUT

The use of fully balanced XLR inputs can be used in cases when the distance between the Supernova Luminous and the audio source is excessive and susceptible to noise interference. The XLR input is a true balanced input. Both conductors are isolated relative to ground.

(3) REMOTE EYE INPUT

Simply plug in the remote eye provide in the REMOTE input. Once plugged in, place the remote eye anywhere in the room where it is convenient for the user to control the amplifier's volume using the included remote control.

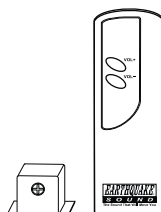

(4) GAIN CONTROL

This knob allows the user to control the volume of the subwoofer. Always start at the lowest setting and slowly increase the volume until the desired subwoofer level is reached. We suggest keeping the Supernova's VOLUME knob between the 10 and 2 o'clock position and controlling its volume level through the output controls of your surround sound processor.

(5) LOW PASS FILTER

The 24dB/octave variable low pass filter from 50-150Hz is designed to control the subwoofer's cutoff frequency. The recommended general setting is at the 2 o'clock position.

(6) PHASE SHIFT SWITCH

This 0°-180° switch allows the user to synchronize the subwoofer to obtain a better and more precise bass response.

(7) 12 VOLT TRIGGER

This feature allows the user to power on the LM1000 amplifier from your home A/V receiver. If supported, when your A/V receiver is turned on a 12V signal is sent to the subwoofer and will turn on when the power switch is in the off position.

(8) AC POWER SOCKET & BUILT-IN FUSE

Always replace the protection fuse with a similar value fuse. For your convenience, an extra fuse is provided in the compartment located right below the AC power socket. To access the extra fuse you simply unplug the power cable from the subwoofer, place a flat-head screwdriver in the small notch and gently pry it open.



(9) POWER SWITCH & LED INDICATOR

When the toggle switch is in the **ON** position, the signal detection circuitry is engaged and the subwoofer is in **AUTO ON/OFF** mode. When the switch is in the OFF position, the amplifier is shut down completely.

The power LED indicates whether the subwoofer is connected to a power source. When plugged in to a power source, the LED will remain glowing green at all times regardless of the power toggle switch position.

NOTE: If the LED indicator does not illuminate, check the built-in fuse using the method described above.

Placing Your Subwoofer(s)

You often hear the term “subwoofers are non-directional.” This is not true. It is harder to choose subwoofer placement when low frequencies are crossed. The wider the room, the more directional the subwoofer. The easiest solution is to use two (2) subwoofers, feed a mono signal to both and place them in front, one on the left and another on the right.

While having two (2) subs is better than one, the MONO signal that drives those subs keeps them from projecting the three dimensional images in the sub-harmonics. Using two (2) subwoofers allows you to cross the subs up to 250Hz sound quality, imaging and staging. In some applications, you might have small front speakers or planar speakers. The two-front-subwoofer system is an excellent solution to planar speakers’ low frequency response early roll off from 150Hz on down. When placing these subwoofers in close proximity to the stereo satellite, the subs will enhance low frequency extension. It will be better to have a stereo subwoofer to help in the lower bass notes and their placement.

Suppose you have only one (1) subwoofer in the room and it is placed on the right side of the room. If a bass guitar player was standing on the left side of the stage and played an EE note (42Hz), then the sub will also respond to that from the right side of the room and completely destroy the stage.

You will see illustrations showing the two (2) different suggested setups. In each of them, note the breakaway and the image separation represented by the black and gray arrows.

 The black arrows represent the sub-harmonic frequencies

 The gray arrows represent the lows, mids, and highs as they follow the action.

The best response is achieved when the subharmonic frequencies are dynamically synchronized with the rest of the audio system, the black and gray arrows are identical.

Single Subwoofer Setup

This is a GOOD setup. The sub-harmonic frequencies (black arrow) always move towards the sub in the single sub setup while the lows, mids, and highs (gray arrow) follow the action.

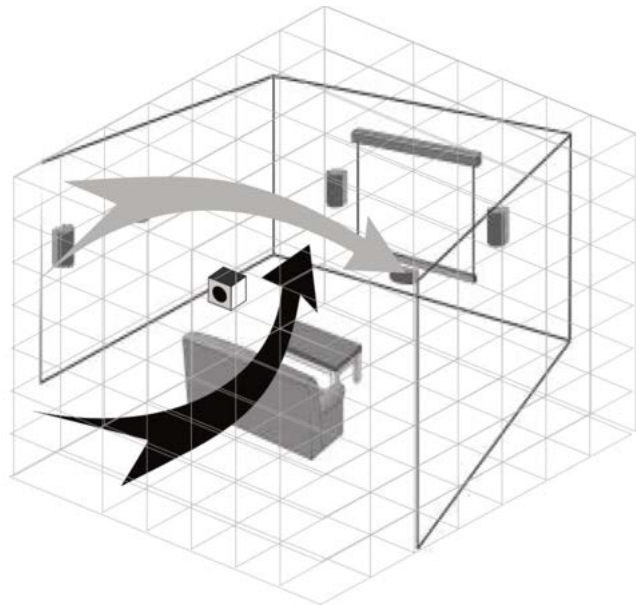

Placing the subwoofer in the corner of the room will produce a more boomy effect, often preferred for movies and sound tracks. For a music application, place the subwoofer as show above or against the front wall, about a third of the room width.

Dual Subwoofer Setup With Mono Signal

This is a BETTER setup. In a dual subwoofer setup, the sub-harmonic frequencies (black arrow) always move towards the middle of the room while the lows, mids, and highs follow the action (gray arrow).

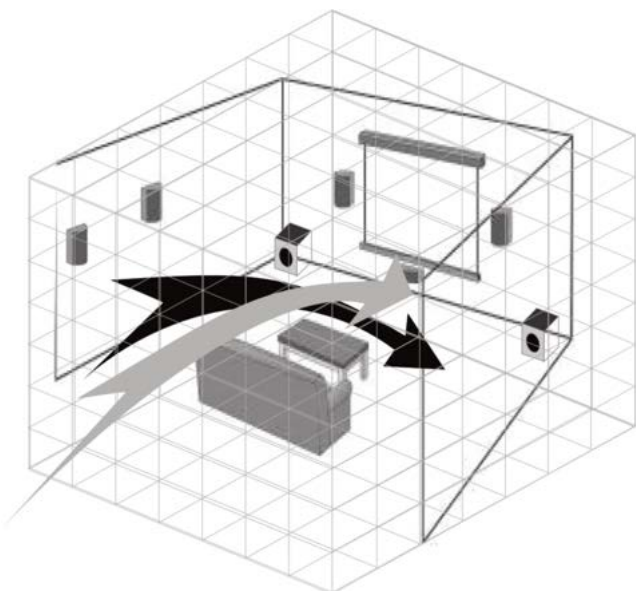

Notice the breakaway and image separation is less in this setup than the single subwoofer setup.

Connecting Your Subwoofer(s)

Earthquake Sound has provided both RCA Low Level and Balanced XLR inputs that give users an alternate option when connecting the subwoofer. It is important that you slide the MODE switch found between the inputs to either the left if using Low Level RCA cables or to the right if using an XLR cable.

Low Level Setup

Today, all signal processors come equipped with built-in pre-amplifier outputs (RCA) that include a subwoofer output. Generally, the SUB PRE OUT is in mono format. Connect the SUB PRE OUT from the processor to the Supernova LM1000 amplifier using a "Y" RCA cable. In case your processor has 2 SUB OUT, only use 1 per subwoofer

We strongly recommend that you use the best available RCA connectors and cables. High quality cables are normally triple shielded and the connectors are gold plated with forceful grasping.

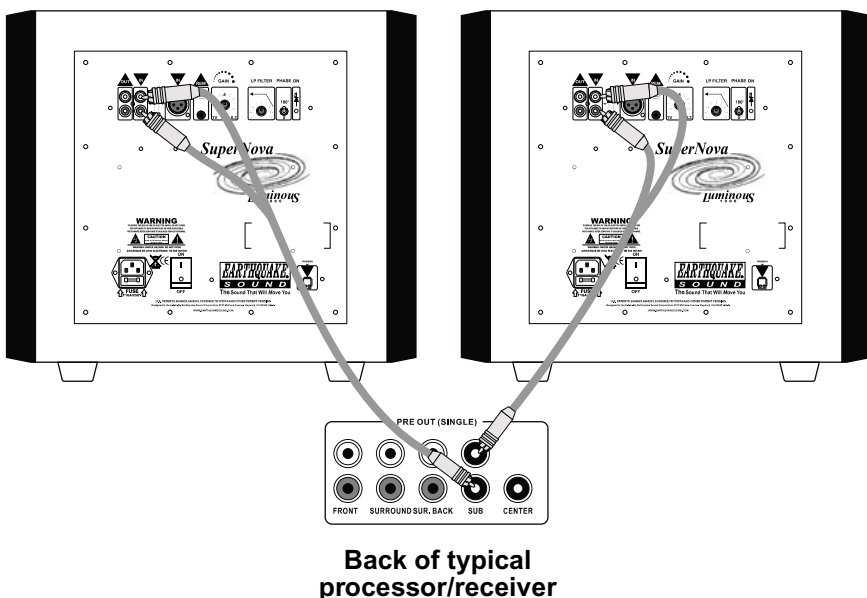

Balanced XLR

Balanced XLR cables can be used on this amplifier when Refer to the XLR pinout diagram below if using XLR connectors on the Supernova Luminous amplifier.

XLR PINOUT DIAGRAM Front view of XLR connectors

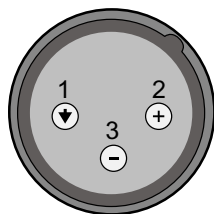

MALE

- 1 + / hot in-phase
- 2 - / cold / out-of-phase
- 3 ▼ / shield / drain wire

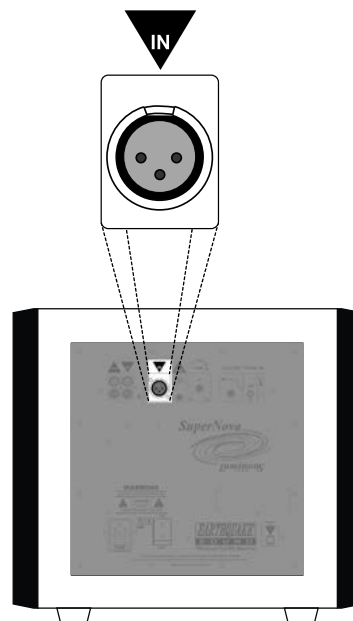

Troubleshooting

If you experience hum noise coming from the subwoofer, try the following steps to resolve the issue.

1. Power off the subwoofer.
2. Turn off the Audio/Video (A/V) receiver.
3. Unplug RCA or XLR cables from the subwoofer.
4. Power the subwoofer back on.
5. If you are still experiencing hum noise please call or email tech support so that an Earthquake Sound technician can assist you.

Phone: 510-732-1000

Email: tech@earthquakesound.com

Tuning Your Subwoofer(s)

The Supernova Luminous is a “True Subwoofer” and must never be operated above the sub-harmonic/harmonic frequency range. Its frequency response is limited by the built-in crossover which has an upper end of 150Hz. However, in most applications, the crossover should not be set above 80Hz. The Supernova MKV's crossover is equipped with a fourth-order Linkwitz-Riley filter (24dB/octave) which blocks vocals from interfering with its performance.

When setting up the Supernova Luminous as part of a home audio system, one must understand that the settings required for music are different than the settings for movie viewing.

FOR MUSIC

In order to set up the Supernova Luminous for music, users must recognize the frequency response and limitations of their existing front and surround speakers (i.e. speaker sizes and SPLs).

- (1) Position the Supernova Luminous in the corner of the room
- (2) Turn the sub around so that the controls are accessible.
- (3) Turn on the audio system, switch the surround processor to “MUSIC” mode, and equalize the rest of audio system.
- (4) Connect the Supernova Luminous to the processor using high quality (triple shielded) RCA cable(s).
- (5) Set the FILTER to the maximum position (150Hz) and the VOLUME to the minimum position (0).
- (6) Optimize the subwoofer's performance by rotating the VOLUME knob to somewhere between the 10 o'clock and 2 o'clock position. This will fully engage the ODL (Optical Distortion Limiting) circuitry, allowing the amplifier to deliver maximum output with minimal distortion.

NOTE:

Some audio processors come equipped with high level voltage on the RCA subwoofer outputs. In such case, you might experience some clipping even when the Subwoofer's volume is set under the 10 o'clock position. One solution is to feed the audio signal to the Supernova Luminous using only 1 (one) RCA input instead.

(7) With the crossover opened to 150Hz, vocals will be heard out of the subwoofer. Gradually rotate the FILTER knob counter clockwise until the vocals are eliminated (typical crossing point of 80Hz).

We suggest keeping the Supernova subwoofer's VOLUME knob between 10 and 2 o'clock position and controlling its volume level through the output controls of your surround sound processor.

In case the subwoofer becomes out of phase with the main front speakers, flip the phase switch to correct the problem. Note that maximum bass is only achieved when the sub is in phase with the speakers in your system.

Once you set up the proper mix of low frequencies and sub-harmonic response that do not encroach on the rest of the speakers, you are ready to set the Supernova MKV for home theater use.

FOR MOVIE VIEWING

The Supernova MKV can be set up to your preference. There are no rules of thumb to how much bass is ideal for movie viewing. Some people like to feel the overwhelming bass as it brings the action and events closer to real life. When viewing movies, a 10dB gain above the music setting is often pleasant for a more realistic feel of the movie.

If you prefer to have different crossover settings for music and movie viewing, we suggest crossing the Supernova MKV at a higher frequency setting and using the processor to control the desired lower crossing point.

Supernova MKV Subwoofer Dimensions & Specifications

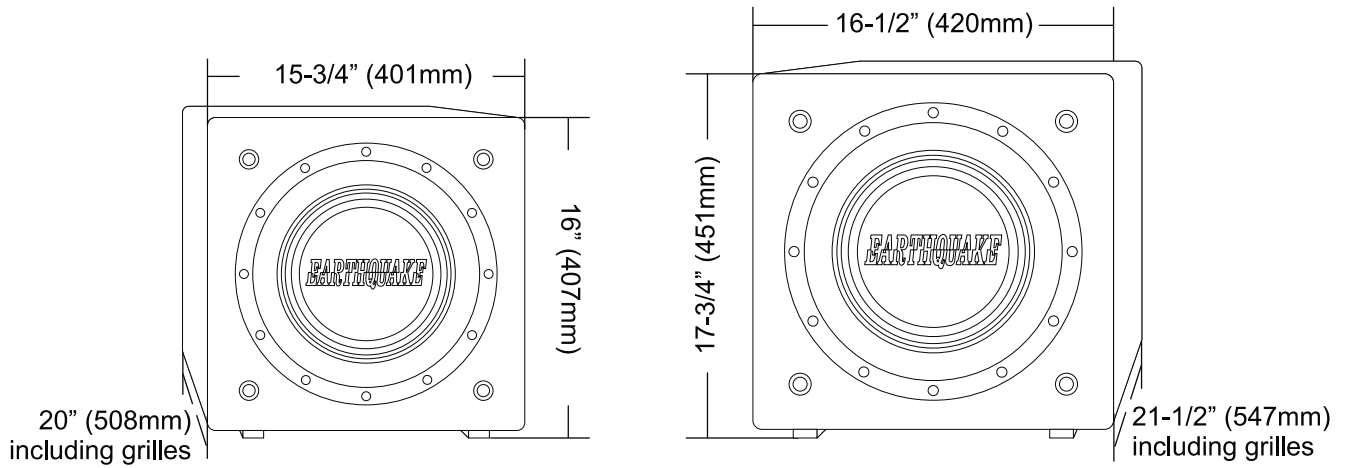

SUPERNOVA LUMINOUS SUBWOOFER		
	LU-12	LU-15
POWER HANDLING	600 WRMS 1200 PEAK	600 WRMS 1200 PEAK
INPUT IMPEDANCE	18 kOhm	18 kOhm
FREQUENCY RESPONSE	18Hz-145Hz	17Hz-120Hz
ENCLOSURE TYPE	Sealed with Passive Radiator	Sealed with Passive Radiator
AVAILABLE FINISHES	BLACK PIANO	BLACK PIANO

** Check the size and finish of your subwoofer to find out your model number.*

5 Year Limited Warranty Information

Earthquake warrants the original purchaser that all **Factory Sealed New Audio Products** to be free from defects in material and workmanship under normal and proper use for a period of five (5) years from the date of purchase (as shown on the original sales receipt with serial number affixed/written on it).

The five (5) year limited warranty period is valid only if an authorized Earthquake dealer properly installs the product and the warranty registration card is properly filled out and sent to Earthquake Sound Corporation. If a non-authorized party installs the product, a ninety (90) day warranty period will be applied.

(A) Five(5) years limited warranty plan coverage guidelines:

First year: Earthquake pays for labor, parts, and ground freight (only in US mainland, not including Alaska and Hawaii. Shipping to us is not covered).

Second, third, fourth & fifth year: Earthquake pays labor only. Customer must pay for parts and freight both ways.

(B) Warning:

Products (sent in for repair) that are tested by Earthquake technicians and deemed to have no problem will not be covered by the limited warranty. Customer will be charged a minimum of one (1) hour of labor (at ongoing rate) plus shipping charges back to customer. Each product sent in for repair must be packaged in its original packaging. Otherwise, **repackaging charges will apply in addition to the labor, parts and shipping charges.**

(C) Earthquake will repair or replace at our option all defective products/parts subject to the following provisions:

- Defective products/parts have not been altered or repaired by anyone other than an Earthquake factory approved technician.
- Products/parts are not subjected to negligence, misuse, accident or damage by improper line voltage.
- Products/parts were used with incompatible products.
- The serial number or any part of the product has been altered, defaced or removed.
- Products/parts have been used in any way that is contrary to Earthquake's written instructions.

(D) Warranty Limitations:

Warranty does not cover products that have been modified or abused, including but not limited to the following:

- Damages to speaker cabinet and cabinet finish due to misuse, abuse or improper use of cleaning materials/methods.
- Bent speaker frame, broken speaker connectors, hole(s) in speaker cone, hole(s) in surround &/ dust cap, and burnt speaker voice coil.
- Fading and/or deterioration of speaker components & finish due to improper exposure to elements.
- Bent amplifier casing, damaged finish on the casing due to abuse, misuse or improper use of cleaning material.
- Burnt tracers on PCB.
- Product/part damaged due to poor packaging or abusive shipping conditions.
- Subsequent damage to other products.

A warranty claim will not be valid if the warranty registration card is not properly filled & returned to Earthquake with a copy of the sales receipt.

(E) Service Request:

To receive product service, contact Earthquake Service Department at (510) 732-1000 and request an RMA number (Return Material Authorization). Items shipped without a valid RMA number will be refused. Make sure you provide us with your complete/correct shipping address, a valid phone number, and a brief description of the problem you are experiencing with the product. In most cases, our technicians might be able to resolve the problem over the phone, thus eliminating the need to ship the product.

(F) Shipping Instructions:

Product(s) must be packaged in its original protective box(es) to minimize transport damage and prevent repackaging cost (at the ongoing rates). Shipper claims regarding items damaged in transit must be presented to carrier. Earthquake Sound Corporation reserves the right to refuse improperly packed product. Original bill of sale must accompany product returned to service. We encourage you to include with the package a written description of the problem. Ship product to:

Earthquake Sound Corp.
2727 McCone Avenue, Hayward, CA 94545
Tel: (510) 732-1000

You are responsible for the cost of shipping the product to Earthquake Sound Corporation.

(G) Disputes Resolution:

All disputes between clients and Earthquake Sound Corporation resulting from the five (5) year limited warranty policy must be resolved according to the laws & registration of the county of Alameda, California.

For Your Records

Model Number: _____

Serial Number: _____

Date of Purchase: _____

Authorized Dealer/Installer Info:

Name: _____

Address: _____

Phone: _____



The Sound That Will *Move* You

Earthquake Sound reserves the right to amend details of the specifications without notice.

© Copyright Earthquake Sound Corporation

Earthquake Sound Corporation

2727 McCone Avenue, Hayward CA, 94545, USA

Phone: 510-732-1000 Fax: 510-732-1095