

EARTHQUAKE EARTHQUAKE®

***DJ-QUAKE SUB* VER 2**

12-inch Powered Subwoofer

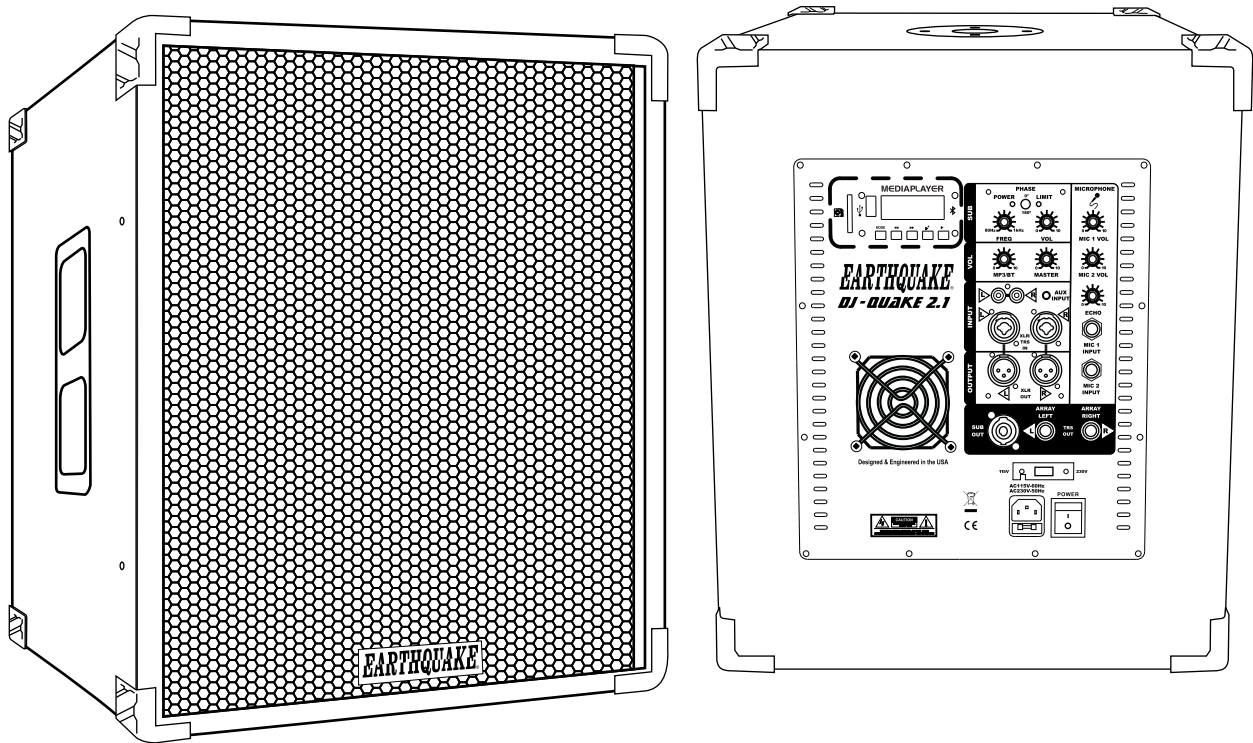

Owner's Manual

Table of Contents

Introduction and Safety Instructions.....	2
About Earthquake Sound Corporation.....	3
Subwoofer Overview.....	4 - 6
Connection Examples.....	7 - 9
Dimensions and Specifications.....	10
Warranty Information.....	11

Introduction

DJ-Quake Sub ver 2 is the new and improved powered subwoofer for the DJ-Quake 2.1 system. This 12-inch subwoofer has a built-in 1200-Watt amplifier (600 Watts RMS). It features balanced (RCA/AUX) and unbalanced (XLR/TRS) line inputs, two MIC inputs as well as a digital media player with USB/SD and Bluetooth® inputs. Additionally, the DJ-Quake Sub ver 2 has balanced (XLR/TRS) and speakon (for added passive sub) outputs.

Safety Instructions

- 1) Read these instructions in their entirety.
- 2) Store this manual and packaging in a safe place.
- 3) Heed all warnings.
- 4) Follow instructions (do not take shortcuts).
- 5) Do not use this apparatus near water.
- 6) Clean only with a dry cloth.
- 7) Do not block any ventilation openings. Install in accordance with the manufacturer's instructions.
- 8) Do not install near any heat sources such as radiators, heat registers, stoves, or other apparatuses that produce heat.
- 9) To reduce the risk of fire or electric shock, do not expose this apparatus to rain or moisture.



The Sound That Will *Move* You

Earthquake Sound Corporation
2727 McCone Avenue
Hayward, CA 94545
United States of America
Tel: 510-732-1000
Fax: 510-732-1095

© Earthquake Sound Corporation. All rights reserved.

This document should not be construed as a commitment on the part of Earthquake Sound Corporation.

The information is subject to change without notice.

Earthquake Sound Corporation assumes no responsibility for errors that may appear within this document.

About Earthquake Sound Corporation

For over 30 years, Earthquake Sound has been producing a variety of high quality audio products that have impressed audiophile communities around the world. It all started in 1984 when Joseph Sahyoun, a music freak and Aerospace Engineer unhappy with the existing loud speaker technology and performance, decided to put his advance engineering knowledge to use. He pushed technological boundaries to the limit to create the kind of subwoofer he could live with. Earthquake quickly created a name for itself in the car audio industry and became well known for its powerful subwoofers and amplifiers. In 1997, using his existing expertise in the audio industry, Joseph Sahyoun expanded his company to home audio production.

Earthquake Sound has since evolved into a leader in the home audio industry, producing not only subwoofers and amplifiers but surround speakers and tactile transducers as well. Engineered by audiophiles for audiophiles, Earthquake Sound audio products are meticulously crafted to reproduce each and every single note perfectly, bringing your home theater experience to life. With true dedication and full attention to details, Earthquake Sound engineers continuously develop new and better products to meet customers' needs and go beyond their expectations.

From mobile audio to prosound and home audio, Earthquake Sound has been selected as the winner of many prestigious awards based on sound quality, performance, value and features. CEA and numerous publications have awarded Earthquake Sound with over a dozen design and engineering awards. Additionally, Earthquake Sound has been granted many design patents by the USPO for revolutionary audio designs that have changed the sound of the audio industry.

Headquartered in a 60,000 square foot facility in Hayward, California USA, Earthquake Sound currently exports to over 60 countries worldwide. In 2010, Earthquake Sound expanded its export operations by opening a European warehouse in Denmark. This accomplishment was recognized by the US Department of Commerce who honored Earthquake Sound with an Export Achievement award at the 2011 Consumer Electronic Show. Just recently, the US Department of Commerce presented Earthquake Sound with another Export Achievement award for expanding its export operations in China.

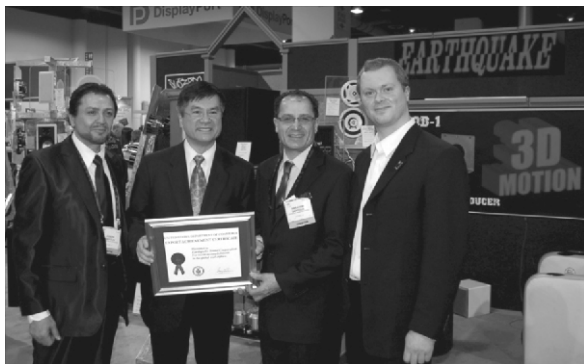

Joseph Sahyoun, US Secretary of Commerce Gary Locke, Abraham Sahyoun and Thomas Mygind



US Commercial Officer Sarah Fox and Joseph Sahyoun



Amplifier Overview

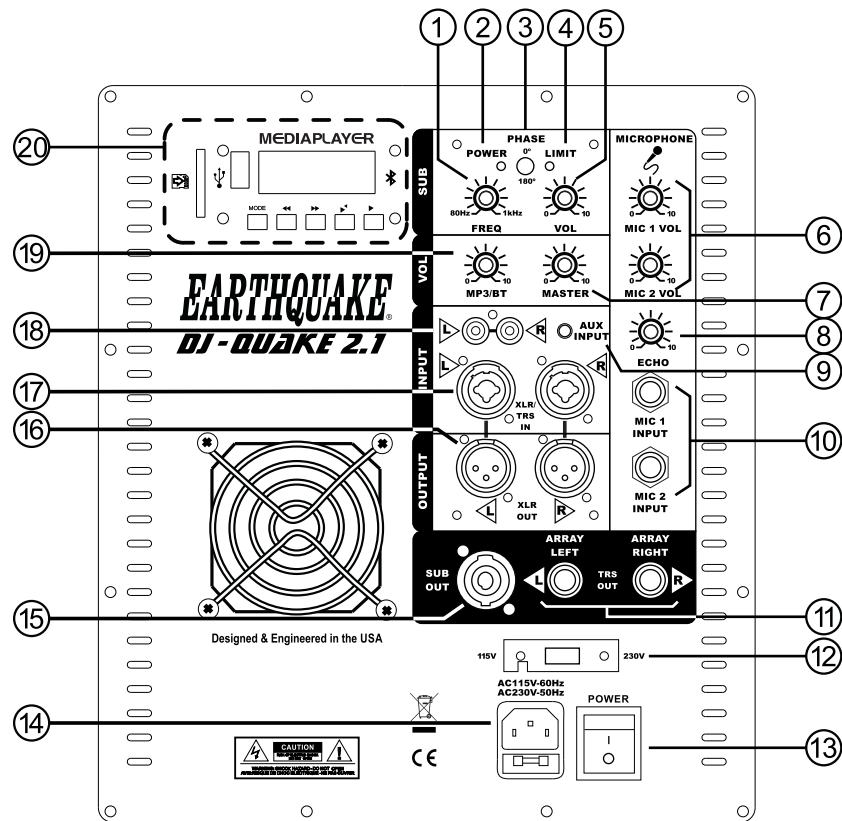

- ① **SUB FREQUENCY CONTROL**
 Use this 80Hz - 1kHz knob to set the subwoofer's cut off frequency. Signals above the set crossover frequency will be gradually rolled off to prevent them from interfering with the array speakers.
- ② **POWER LED**
 This green LED indicator reflects the main power status of the amplifier. The LED will light up only when the sub is connected to a power source and its main power switch is in the ON position.
- ③ **PHASE SWITCH**
 This 0° (out) / 180° (in) phase switch allows user to synchronize the subwoofer to obtain better and more precise bass response.
- ④ **LIMIT LED**
 This red LED indicator will light and flash when the amplifier senses distortion on the sub. Simply reduce the input's volume when this LED lights up.
- ⑤ **SUB VOLUME CONTROL**
 Use this knob to adjust the volume of the subwoofer and any auxiliary sub.
- ⑥ **MIC1 & MIC2 VOLUME CONTROL**
 Use this knob to control the volume of the microphones.
- ⑦ **MASTER VOLUME CONTROL**
 Use this knob to control the volume of the entire DJ-Quake system (subwoofers and array speakers).
- ⑧ **ECHO LEVEL CONTROL**
 Use this knob to increase or reduce the microphones' echo effect.
- ⑨ **AUXILIARY INPUT**
 Use this 3.5mm unbalanced stereo input to connect the DJ-Quake system to a computer, mobile device, etc.

⑩ **MICROPHONE INPUT**
Use this 1/4" TRS connectors to connect the microphone to the DJ-Quake system.

⑪ **SPEAKER OUTPUT**
Use these 1/4" TRS connectors to link the left and right array speakers to the subwoofer.
We recommend using the DJ-Quake Array (sold separately or as part of the DJ-Quake 2.1 system) which comes complete with two (2) 16.5-foot (5m) 1/4" TRS to 1/4" TRS speaker cables.

⑫ **115/230V AC SELECTOR**
The DJ-Quake 2.1 system can operate in a 115V or 230V environment. Before connecting the DJ-Quake to a power source, simply slide the selector switch to the required power input setting.

WARNING Use of improper voltage may result in hazardous conditions and/or damage the DJ-Quake components that are not covered by the factory warranty.

CAUTION For your safety, please make sure the sub is not connected to any power source prior to accessing the AC selector and fuse compartment.

⑬ **MAIN POWER SWITCH**
This switch controls the AC power going to the DJ-Quake system. We suggest keeping the switch in the OFF position when the system is not being used for an extended period of time.

⑭ **AC POWER WITH BUILT-IN FUSE**
This AC line connector is fused to protect the amplifier from unwanted power surges. Be sure to use the proper fuse rating (Ø5 x 20mm 5A/250V UL/VDE slow blow tube fuse) when replacing the existing fuse.
To access the fuse compartment, simply unplug the power cable from the subwoofer, place a flat-head screwdriver in the small notch and pry it open.

⑮ **PASSIVE SUB LINK**
Use this speakon connector to connect a passive subwoofer (with a minimum impedance of 8 Ohms) for a bass boosting performance.

⑯ **BALANCED XLR OUTPUT**
Use these XLR connectors to link additional speakers or subwoofers to the DJ-Quake system.

NOTE: This input is activated only when using the XLR or 1/4" TRS balanced inputs.

⑰ **BALANCED INPUT**
Use these XLR and 1/4" TRS combo jack to connect the DJ-Quake system to an audio interface or mixer.

WARNING Connect only one input source at a time.

⑱ **UNBALANCED RCA INPUT**
Use this RCA input to connect the DJ-Quake system to a computer, mobile device, etc.

⑲ **MULTI-MEDIA VOLUME CONTROL**
Use this knob to adjust the volume for the input when using USB/SD or Bluetooth® mode.

⑳ **MULTI-MEDIA PLAYER**
Please refer to the next page for details of this digital media player.



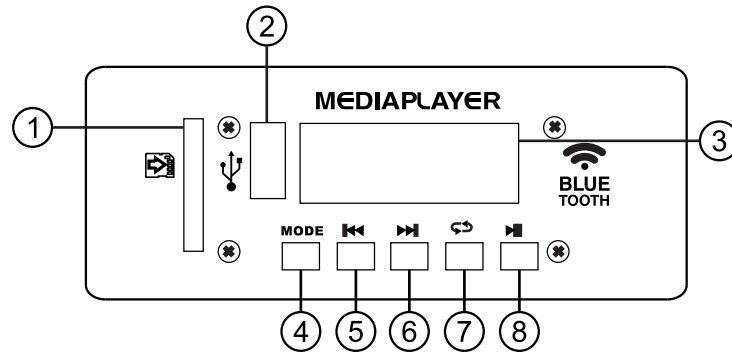





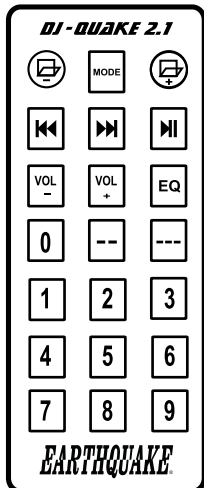

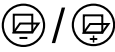

Media Player Overview



- ① **SD/MMC PORT**
Use this port when sourcing MP3 media from a pre-loaded SD/MMC card.
- ② **USB PORT**
Use this port when sourcing MP3 media from a USB drive.
- ③ **LCD DISPLAY SCREEN**
This screen will help you navigate between the modes and folders. If there is no source connected to the system, the screen will show "NO" for no source.
- ④ **MODE BUTTON**
Press this button to switch between USB/SD, Bluetooth® and LINE IN modes.
- ⑤ **PREVIOUS BUTTON**
When using USB/SD mode, press this button to go back to previous track.
- ⑥ **NEXT BUTTON**
When using USB/SD mode, press this button to go to the next track.
- ⑦ **REPEAT BUTTON**
When using USB/SD mode, press this button to repeat the MP3 song.
- ⑧ **PLAY/PAUSE BUTTON**
Press this button to play or pause the MP3 song when using USB/SD mode.

Remote Control Functions



-  /  Press these buttons to access the previous (-) or next (+) folder when using USB/SD mode.
-  Press this button to switch from USB/SD, Bluetooth® and LINE IN modes.
-  /  Press this button to go to the previous or next song when using USB/SD mode.
-  Press this button to play or pause when using USB/SD mode.
-  /  Press these buttons to decrease (-) and increase (+) the volume.
-  Press this button to select from the 5 preset EQs: Pop, Rock, Jazz, Classic and Country
-  Press this button to select songs by 10 digit numbers.
-  Press this button to select songs by 100 digit numbers.
-  Press these number buttons to select the MP3 files.

Line Connection Diagrams

While the DJ-Quake system is compatible with MP3 pre-loaded USB/SD card and Bluetooth®, it also has a multitude of different connection scenarios when using LINE IN as your input mode, enabling you easily connect a number of different audio sources and devices to achieve the desired performance and sound quality.

CONNECTING THROUGH AUXILIARY INPUT

One of the easiest and quickest connection to the DJ-Quake system is through the auxiliary input. Any device with a 3.5mm connection may be connected into the DJ-Quake system and used as the primary source.

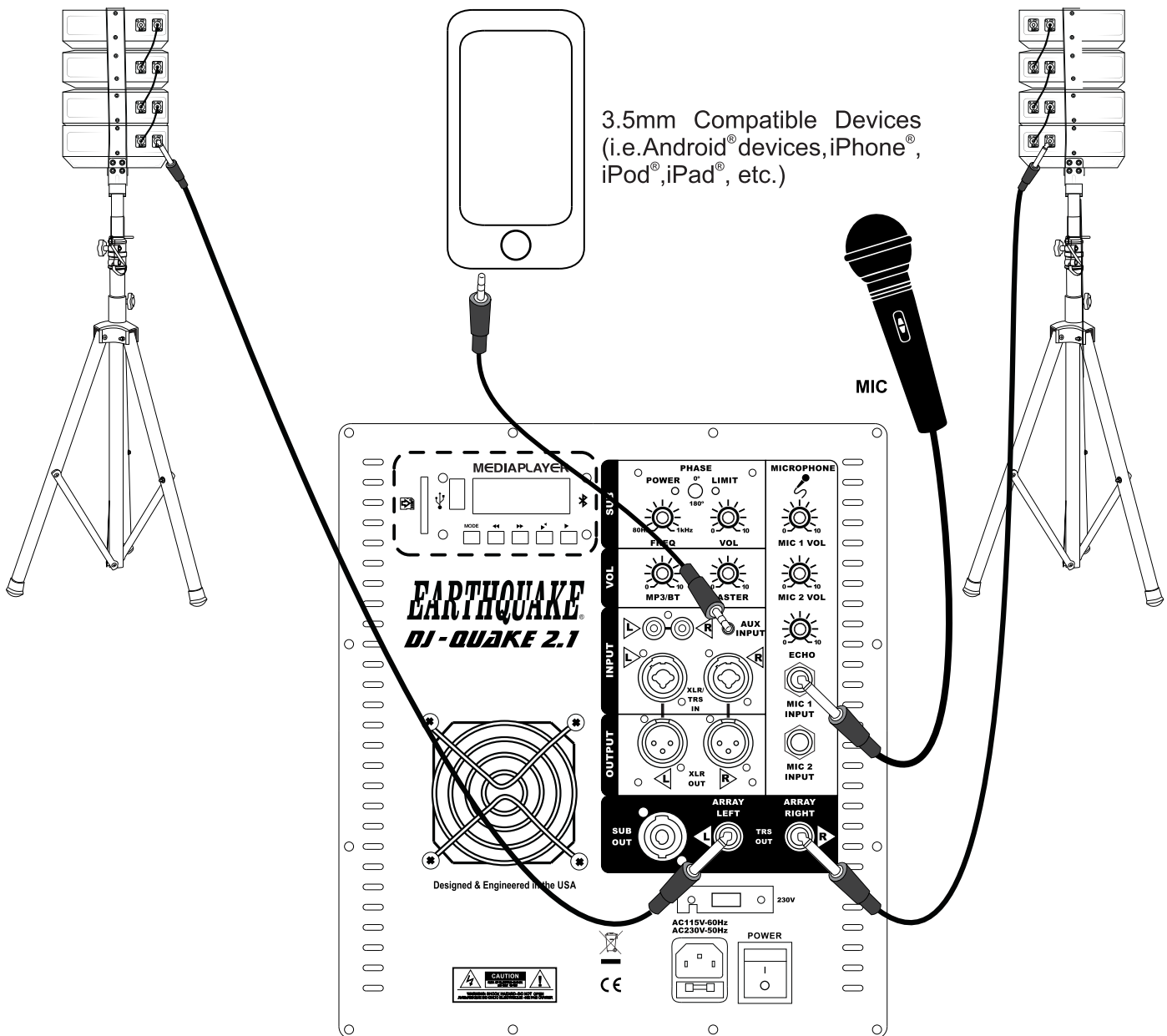



The Sound That Will *Move* You

Earthquake Sound Corporation

2727 McCone Avenue. Hayward CA, 94545. USA

US Toll Free: 800-576-7944 | Phone: 510-732-1000 | Fax: 510-732-1095

www.earthquakesound.com